

3.0 ENGLISH SECTION A: LANGUAGE

THE KENYA NATIONAL EXAMINATIONS COUNCIL
Kenya Certificate of Primary Education

501

— ENGLISH —
SECTION A: LANGUAGE
Oct. 2019 – 1 hour 40 minutes



INSTRUCTIONS TO CANDIDATES (Please read these instructions carefully)

1. You have been given this question booklet and a separate answer sheet. The question booklet contains 50 questions.
2. When you have chosen your answer, mark it on the **ANSWER SHEET**, not in this question booklet.

HOW TO USE THE ANSWER SHEET

3. Use an ordinary pencil.
4. Confirm that the answer sheet that you have been provided with has the following:
YOUR INDEX NUMBER
YOUR NAME
NAME OF YOUR SCHOOL
5. Do not make any marks outside the boxes.
6. Keep the sheet as clean as possible and do not fold it.
7. For each of the questions 1–50, four answers are given. The answers are lettered A, B, C and D. In each case only **ONE** of the four answers is correct. Choose the correct answer.
8. On the answer sheet, the correct answer is to be shown by drawing a **dark line** inside the box in which the letter you have chosen is written.

Example:

In the Question Booklet.

For question 23, choose the alternative that best completes the sentence.

23. She passed her exams very well, _____?

- A. is it
- B. did she
- C. didn't she
- D. isn't it

The correct answer is C.

On the answer sheet:

23 [A] [B] [C] [D]

In the set of boxes numbered 23, the box with the letter C printed in it is marked.

9. Your **dark line MUST** be within the box.
10. For each question, **ONLY ONE** box is to be marked in each set of four boxes.

This question paper consists of 7 printed pages.



909501



Turn over

Read the passage below. It contains blank spaces numbered 1 to 15. For each blank space, select the best alternative from the choices given.

You are in the middle of a test. There is 1 silence in the classroom. You are beginning to feel hungry. It is nearly lunch hour and you are thinking of how nice a 2 of ugali and stew 3 be. Suddenly, without 4 warning at all, your stomach 5 a loud growling sound. Your classmates start to giggle and you almost die of 6.

Why does your stomach 7 that way? When you are hungry, your stomach begins to 8 digestive juices. These juices churn, meaning they move around the stomach ready to digest food. This movement is what causes the growling sound. When you eat some food to 9 your hunger, the juices will not churn as there is now something to work 10.

The churning of juices is the stomach's way of alerting you that it is time to eat. This, 11, is not the body's 12 way of informing you that you are hungry. Your brain also plays an 13 part in this regard. There is a section of the brain called the 'appetate' 14 tells your body when you are hungry as 15 as when to stop eating.

- | | | | |
|--------------------|--------------|--------------|------------------|
| 1. A. full | B. total | C. overall | D. entire |
| 2. A. quantity | B. share | C. serving | D. portion |
| 3. A. would | B. will | C. should | D. shall |
| 4. A. some | B. further | C. much | D. any |
| 5. A. makes | B. gives | C. sends | D. releases |
| 6. A. worry | B. misery | C. anxiety | D. embarrassment |
| 7. A. act | B. behave | C. do | D. perform |
| 8. A. produce | B. give | C. offer | D. avail |
| 9. A. fulfil | B. feed | C. remove | D. satisfy |
| 10. A. for | B. on | C. in | D. with |
| 11. A. however | B. indeed | C. moreover | D. really |
| 12. A. one | B. best | C. own | D. only |
| 13. A. interesting | B. effective | C. important | D. accurate |
| 14. A. who | B. which | C. whose | D. what |
| 15. A. fast | B. soon | C. clearly | D. well |

In questions 16 to 18, select the word which best completes the sentence given.

16. The boy _____ that he had taken the wallet, but nobody believed him.
A. refused
B. denied
C. objected
D. disagreed
17. They did not show any _____ for the help he had given them in the past.
A. remembrance
B. kindness
C. gratitude
D. acceptance
18. The police arrested the motorist for _____ the speed limit.
A. exceeding
B. passing
C. overtaking
D. reaching

In questions 19 and 20, select the sentence which is correct.

19. A. The table has one of it's legs broken.
B. This shop deals with mens clothes.
C. Lets all avoid unnecessary noise.
D. This book is actually not yours.
20. A. I had a long walk along the beech.
B. He has always given me good advice.
C. You are quiet strong, I think.
D. Many people do not like cold whether.

For questions 21 and 22, choose the word which least fits in the group.

21. A. bread
B. butter
C. cheese
D. ghee

22. A. peep
B. stare
C. read
D. glance

23. The words below can be re-arranged to make a correct sentence if one word is omitted.

LAY BUT EGGS PRODUCE NOT
THEY COW DO HENS MILK

Which word should be omitted?

- A. BUT
B. COW
C. NOT
D. EGGS

24. There are three letters that are found in **all** of the following words:

PRAISE CARING MALARIA ARGUING

Which English word can be made from these three letters?

- A. gun
B. ran
C. can
D. air

25. Choose the word which makes this sentence **true**.

A father is always _____ than his son.

- A. taller
B. stronger
C. older
D. cleverer

Read the passage below and then answer questions 26 to 38.

In a small village lived a kind-hearted girl named Kayonga. She lived with her stepmother, who treated her cruelly and made her work like a servant. One day some of Kayonga's young friends went to the temple of their god, Imana, to ask for some teeth to replace those which had fallen out. Kayonga had the same wish but dared not join them because her stepmother had forbidden her to leave the house.

However, that night, when everyone was asleep, Kayonga decided to go to the temple. She walked till dawn before she reached the temple. Imana appeared before her, and she told him her wish. Imana knew that Kayonga was a kind girl, and he **granted her wish**. He also gave her new clothes and changed her into a very beautiful girl. Then he led her safely through the forest to her home. Before parting from Kayonga, Imana gave her a strange order: "Never smile at anyone, under any circumstances."

In the morning, all the villagers were surprised to see the great change in Kayonga. Her stepmother was jealous and said, "You stole the clothes and jewellery. How else could you have got them?" No one **took heed of** what the stepmother said. Instead, they were happy for Kayonga for her good fortune.

One day, a young man named Esiroma met Kayonga and fell in love with her. He asked for her hand in marriage. Kayonga agreed and went to live with Esiroma and his parents. They loved her but were **puzzled** when they discovered that she never smiled.

Everyone in the village rejoiced when Kayonga gave birth to a son. Even that happy event did not make Kayonga smile. When the son was about five years old, Kayonga's stepmother took him aside and said, "Do not eat any food that your mother gives you. Tell her that you will eat only when she smiles at you."

The frightened child did what his grandmother told him. But Kayonga took no notice, although her son cried for a long time. He died soon afterwards. Kayonga was heart-broken.

Later Kayonga gave birth to another son. The stepmother asked that child to do the same thing. Kayonga again refused to smile, and that son died too.

Then a little girl was born to Kayonga. Kayonga was afraid that she might die too. She took her daughter to the grave of her two sons and prayed to Imana.

"Please have mercy on me," she cried.

Imana appeared before her. "You have been very obedient," he said, "and I have decided to reward you. Life is restored to your sons! Smile at them, and be happy!"

At once Kayonga's sons appeared. Imana took all of them back to the village. He explained to Esiroma what had happened.

"You shall live happily together from this time onwards," Imana said. "However, the one who caused all your sorrows shall perish!"

After saying this, a dense black cloud covered the hut in which Kayonga's stepmother lived. Lightning came from the clouds and struck the hut, setting it on fire. The stepmother died in the flames.

26. What were Kayonga's friends going to the temple to do?
- To ask Imana for new clothes and jewellery.
 - To pray to Imana for some new teeth.
 - To request Imana to make them beautiful.
 - To tell Imana to grant them all their wishes.
27. Why did Kayonga not accompany her friends to the temple of Imana?
- Her stepmother would not allow her to go.
 - Her plan was to go there by herself later.
 - Her stepmother did not like her friends.
 - Her friends would be jealous of her beauty.
28. Why did Kayonga go to the temple of Imana at night?
- So that her beauty could attract many people at dawn.
 - So that her source of beauty may not be revealed.
 - So as to avoid being discovered by her step-mother.
 - So as to have all of Imana's kind attention.
29. Imana 'granted her wish'. This means that
- Imana listened to Kayonga's story.
 - Imana gave Kayonga some new clothes.
 - Imana guided Kayonga through the forest.
 - Imana replaced Kayonga's fallen teeth.
30. What did Imana order Kayonga to do?
- To avoid smiling at anyone.
 - To be happy all the time.
 - To marry a man named Esiroma.
 - To avoid shedding tears at all times.
31. When Kayonga's stepmother saw the beautiful clothes and jewellery,
- she was curious and wanted to know the source.
 - she was very envious and accused Kayonga of theft.
 - she was surprised and wished Kayonga was her real daughter.
 - she was worried and started asking Kayonga many questions.
32. The words 'took heed of' in the story could be replaced by
- wanted to hear.
 - made an observation.
 - paid attention to.
 - wished to remember.
33. Each of the following words can be used to replace 'puzzled' except
- perplexed.
 - baffled.
 - confused.
 - terrified.
34. Kayonga's two sons died because
- they became sad since their mother was never happy with them.
 - they were secretly poisoned by Kayonga's jealous stepmother.
 - they got frightened to death by their grandmother's threats.
 - they refused to eat unless Kayonga smiled at them.
35. As a reward for Kayonga's obedience, Imana
- changed her into a beautiful girl and gave her new clothes and jewellery.
 - allowed her to smile again and brought her two sons back to life.
 - gave her a beautiful daughter and granted her all the wishes she had.
 - cured her illness and helped her to live happily with her husband and children.
36. What major lesson do we learn from Kayonga's experience?
- when we are faced with trouble, we should act wisely.
 - when we obey, good things will come our way.
 - we should be brave enough to pursue our goals in life.
 - we should pray earnestly for the things we need.
37. What do we learn from what finally happens to Kayonga's stepmother?
- Patience pays in the end.
 - Blood is thicker than water.
 - Evil begets evil.
 - Prayer solves everything.
38. Which of the following would be the **best** title for this story?
- Kayonga's evil stepmother
 - Kayonga's happy life
 - Kayonga smiles again
 - Kayonga marries Esiroma

Read the following passage and then answer questions 39 to 50.

Accidents happen every day. A family's house catches fire and burns to the ground. Cars and buses collide or overturn. These unfortunate events bring losses to those involved. But the losses can be reduced if people think about these risks in advance and prepare for them. This can be done by means of insurance.

Insurance refers to an agreement in which a person pays a company regular amounts of money and the company agrees to pay for losses that may occur. The document which contains the agreement is called an insurance policy. A person who wants to insure his house against fire, for example, approaches an insurance company. He says how much money his house is worth. If the company agrees that this is the correct value, it will insure the house against fire, provided that the person pays a certain sum of money every year. This payment is called a **premium**. If the house does not burn, that money remains with the company. But if a fire breaks out and destroys the house, the company pays the owner a sum of money equal to the value of the house.

Another common type of insurance is motor vehicle insurance. According to the law, every vehicle in Kenya has to be insured. The law, however, only insists on the kind of insurance that covers other people who may be involved in accidents with the insured vehicle. This is called third-party insurance. If a vehicle owner so wishes, he may also insure the vehicle itself, so that if it is stolen or destroyed in an accident, he will be paid by the insurance company some money to buy a new one. This is known as comprehensive insurance.

Apart from insuring property, one can also insure his or her health. This means the insurance company agrees to pay the person's medical bills in case of illness. Because of the high cost of medical care today, this kind of insurance has become quite popular. Many employers now insure the health of their workers because they know how important it is to have a healthy workforce.

Not all kinds of insurance are aimed at protecting us from **unforeseen** losses. There are some types of insurance that are purely meant to make it easier to manage some responsibilities. For example, there is education insurance. This involves an agreement in which a person pays a regular amount of money over a period of time. After some time, the company pays the agreed amount to cater for the education of the person's dependant. This has been found to be a less burdensome way of paying for education which would otherwise be quite expensive.

There is also life insurance. Here, the company pays an agreed amount of money to the family of the insured person upon his death. This money is meant to take care of the people left behind since it is assumed that the death results in loss of financial support. Nowadays, there are even insurance policies meant to cover funeral expenses upon the death of an insured person.

The whole idea behind insurance is to reduce the impact of financial loss or to make expenses easier to bear. It is not meant to enrich the person insured; nor is it meant to stop people from facing unfortunate events or going through the pain of loss. For property insurance, the cause of the loss or destruction should be beyond the control of the property owner. One cannot be compensated for destroying their own property. Due to its many benefits, more and more people are embracing insurance today.

39. Which of the following is **true** about insurance?
- It helps reduce incidences of fire and accidents.
 - It helps reduce financial losses in case of accidents.
 - It makes people think about dangers at all times.
 - It makes people become more careful about life.
40. People who seek insurance may be described as
- fearful.
 - confident.
 - hopeless.
 - cautious.
41. Which of the following statements best describes a 'premium'?
- An amount of money that a person gets from an insurance company.
 - An amount of money one pays to a company in order to get insured.
 - An amount of money paid to a person if he or she incurs a loss.
 - An amount of money that remains with the company after it pays for losses.
42. Which of the following statements is **not** true about insurance of houses against fire?
- The company and the house owner must agree on the value of the house.
 - The company can only insure the house if the owner pays the premiums as agreed.
 - The company will pay for loss if the house burns, regardless of the cause of fire.
 - The company will keep the premium if the house does not get burned.
43. If an insured four-roomed, two storey building valued at three million shillings gets burned, how much money will the owner get from the insurance company?
- Four million shillings.
 - Three million shillings.
 - Two million shillings.
 - One million shillings.
44. How does an insurance company make money?
- By evaluating the correct value of a house.
 - By asking vehicle owners to take comprehensive insurance.
 - By avoiding to pay all the money claimed.
 - By retaining premiums when losses do not occur.
45. If a car with third-party insurance accidentally hits a pedestrian and gets damaged, who will the insurance company compensate?
- The pedestrian only.
 - The owner of the car only.
 - The one who sold the car.
 - The car owner and the pedestrian.
46. Why do many employers now insure the health of their workers?
- They want to have healthy workers.
 - Health insurance has become quite popular.
 - Workers fall ill too often these days.
 - Medical care has become very costly.
47. The word 'unforeseen' means the same as
- mysterious.
 - strange.
 - new.
 - accidental.
48. Why is it important to have education insurance?
- It enables children to do well in school.
 - It makes education less expensive for parents.
 - It makes it easier to meet school expenses.
 - It enables people to achieve success in life.
49. Life insurance helps the family of the insured person upon his death by
- ensuring the family does not feel too sad.
 - making sure that the family lacks nothing.
 - taking care of the duties of the dead person.
 - offering financial support to the family.
50. Which of the following would be the **best** title for this passage?
- Risks of insurance
 - How insurance works
 - Insuring against fire
 - When to take insurance

4.0 ENGLISH SECTION B: COMPOSITION

THE KENYA NATIONAL EXAMINATIONS COUNCIL
Kenya Certificate of Primary Education

502

— ENGLISH —
SECTION B: COMPOSITION
Oct. 2019 – 40 minutes



YOUR INDEX NUMBER	
YOUR NAME	
NAME OF YOUR SCHOOL	

READ THESE INSTRUCTIONS CAREFULLY

1. In the spaces provided above, write your full Index Number, your Name and the Name of your School.
2. Now open this paper, read the composition subject carefully and write your composition on the lines provided.
3. The composition **must** be written in English.

This question paper consists of 4 printed pages.



909502

© 2019 The Kenya National Examinations Council

502



Turn over

5.0 ENGLISH SECTION A: LANGUAGE HEARING IMPAIRED

THE KENYA NATIONAL EXAMINATIONS COUNCIL
Kenya Certificate of Primary Education

501 HI

— ENGLISH —
SECTION A: LANGUAGE
HEARING IMPAIRED
Oct. 2019 – 2 hours



INSTRUCTIONS TO CANDIDATES (Please read these instructions carefully)

1. You have been given this question booklet and a separate answer sheet. The question booklet contains 50 questions.
2. When you have chosen your answer, mark it on the **ANSWER SHEET**, not in this question booklet.

HOW TO USE THE ANSWER SHEET

3. Use an ordinary pencil.
4. Confirm that the answer sheet that you have been provided with has the following:
YOUR INDEX NUMBER
YOUR NAME
NAME OF YOUR SCHOOL
5. Do not make any marks outside the boxes.
6. Keep the sheet as clean as possible and do not fold it.
7. For each of the questions 1–50, four answers are given. The answers are lettered A, B, C and D. In each case only **ONE** of the four answers is correct. Choose the correct answer.
8. On the answer sheet, the correct answer is to be shown by drawing a **dark line** inside the box in which the letter you have chosen is written.

Example:

In the Question Booklet.

For question 23, choose the alternative that best completes the sentence.

23. She passed her exams very well, _____ ?
- A. is it
 - B. did she
 - C. didn't she
 - D. isn't it

The correct answer is C.

On the answer sheet:

23 [A] [B] [C] [D]

In the set of boxes numbered 23, the box with the letter C printed in it is marked.

9. Your dark line **MUST** be within the box.
10. For each question **ONLY ONE** box is to be marked in each set of four boxes.

This Question Paper consists of 7 printed pages.



909501

© 2019 The Kenya National Examinations Council
501 HI



Turn over

Read the passage below. It contains blank spaces numbered 1 to 15. For each blank space, choose the best alternative from the choices given.

You are in the middle of a test. There is 1 silence in the classroom. You are beginning to feel hungry. It is nearly lunch hour and you are thinking of how nice a 2 of ugali and stew 3 be. Then, without 4 warning at all, your stomach 5 a loud growling sound. Your classmates start to giggle and you almost die of 6.

Why does your stomach 7 that way? When you are hungry, your stomach begins to 8 digestive juices. These juices churn, meaning they move around the stomach ready to digest food. This movement is what causes the loud sound. When you eat some food to 9 your hunger, the juices will not churn as there is now something to work 10.

The movement of juices is the stomach's way of alerting you that it is time to eat. This, 11, is not the body's 12 way of informing you that you are hungry. Your brain also plays an 13 part in this regard. There is a section of the brain called the 'appostat' 14 tells your body when you are hungry as 15 as when to stop eating.

- | | | | | |
|-----|----------------|--------------|--------------|------------------|
| 1. | A. full | B. total | C. all | D. enough |
| 2. | A. quantity | B. share | C. meal | D. portion |
| 3. | A. would | B. will | C. should | D. shall |
| 4. | A. some | B. further | C. much | D. any |
| 5. | A. makes | B. gives | C. sends | D. releases |
| 6. | A. worry | B. suffering | C. fear | D. embarrassment |
| 7. | A. act | B. behave | C. do | D. perform |
| 8. | A. produce | B. give | C. offer | D. avail |
| 9. | A. fulfil | B. feed | C. remove | D. satisfy |
| 10. | A. for | B. on | C. in | D. with |
| 11. | A. however | B. indeed | C. moreover | D. really |
| 12. | A. one | B. best | C. own | D. only |
| 13. | A. interesting | B. effective | C. important | D. accurate |
| 14. | A. who | B. which | C. whose | D. what |
| 15. | A. fast | B. soon | C. clearly | D. well |

In questions 16 to 18, select the word which best completes the sentence given.

16. The boy _____ that he had taken the wallet, but nobody believed him.
A. refused
B. denied
C. objected
D. disagreed
17. They did not show any _____ for the help he had given them in the past.
A. remembrance
B. kindness
C. gratitude
D. acceptance
18. The police arrested the motorist for _____ traffic rules.
A. disobeying
B. driving
C. stopping
D. forgetting

In questions 19 and 20, select the sentence which is correct.

19. A. The table has one of it's legs broken.
B. This shop deals with mens clothes.
C. Lets all avoid unnecessary noise.
D. This book is actually not yours.
20. A. I had a long walk along the beech.
B. He has always given me good advice.
C. You are quiet strong, I think.
D. Many people do not like cold whether.

For questions 21 and 22, choose the word which **least** fits in the group.

21. A. bread
B. butter
C. cheese
D. ghee
22. A. peep
B. stare
C. read
D. glance

23. The words below can be re-arranged to make a correct sentence if one word is left out.

LAY BUT EGGS PRODUCE NOT THEY
COW DO HENS MILK

Which word should be left out?

- A. BUT
B. COW
C. NOT
D. EGGS

24. There are three letters that are found in **all** of the following words:

PRAISE CARING MALARIA
ARGUING

Which English word can be made from these three letters?

- A. gun
B. ran
C. can
D. air

25. Choose the word which makes this sentence **true**.

A father is always _____ than his son.

- A. taller
B. stronger
C. older
D. cleverer

Read the passage below and then answer questions 26 to 38.

In a small village lived a kind-hearted girl named Kayonga. She lived with her stepmother, who treated her cruelly and made her work like a slave. One day some of Kayonga's young friends went to the temple of their god, Imana, to ask for some teeth to replace those which had fallen out. Kayonga had the same wish but could not join them because her stepmother had told her not to leave the house.

However, that night, when everyone was asleep, Kayonga decided to go to the temple. She walked till dawn before she reached the temple. Imana appeared before her, and she told him her wish. Imana knew that Kayonga was a kind girl, and he **granted her wish**. He also gave her new clothes and changed her into a very beautiful girl. Then he led her safely through the forest to her home. Before leaving Kayonga, Imana gave her a strange order. "Never smile at anyone, in whatever situation."

In the morning, all the villagers were surprised to see the great change in Kayonga. Her stepmother was jealous and said, "You stole the clothes and jewellery. How else could you have got them?" No one paid any attention to what the stepmother said. Instead, they were happy for Kayonga for her good luck.

One day, a young man named Esiroma met Kayonga and fell in love with her. He asked her to marry him. Kayonga agreed and went to live with Esiroma and his parents. They loved her but were **puzzled** when they discovered that she never smiled.

Everyone in the village rejoiced when Kayonga gave birth to a son. Even that happy event did not make Kayonga smile. When the son was about five years old, Kayonga's stepmother took him aside and said, "Do not eat any food that your mother gives you. Tell her that you will eat only when she smiles at you."

The frightened child did what his grandmother told him. But Kayonga took no notice, although her son cried for a long time. He died soon afterwards. Kayonga was sad and heart-broken.

Later Kayonga gave birth to another son. The stepmother asked that child to do the same thing. Kayonga again refused to smile, and that son died too.

Then a little girl was born to Kayonga. Kayonga was afraid that she might die too. She took her daughter to the grave of her two sons and prayed to Imana.

"Please have mercy on me," she cried. Imana appeared before her. "You have been very obedient," he said, "and I have decided to reward you. Life is given back to your sons! Smile at them, and be happy!"

At once Kayonga's sons appeared. Imana took all of them back to the village. He explained to Esiroma what had happened.

"You shall live happily together from this time onwards," Imana said. "However, the one who caused all your sorrows shall die!"

After saying this, a heavy black cloud covered the hut in which Kayonga's stepmother lived. Lightning came from the clouds and struck the hut, setting it on fire. The stepmother died in the flames.

26. What were Kayonga's friends going to the temple to do?
- To ask Imana for new clothes and jewellery.
 - To pray to Imana for some new teeth.
 - To request Imana to make them beautiful.
 - To tell Imana to grant them all their wishes.
27. Why did Kayonga not accompany her friends to the temple of Imana?
- Her stepmother would not allow her to go.
 - Her plan was to go there alone later.
 - Her stepmother did not like her friends.
 - Her friends would be jealous of her beauty.
28. Why did Kayonga go to the temple of Imana at night?
- So that her beauty could attract many people at dawn.
 - So that her source of beauty may not be revealed.
 - So as to avoid being discovered by her step-mother.
 - So as to have all of Imana's kind attention.
29. Imana 'granted her wish'. This means that
- Imana listened to Kayonga's story.
 - Imana gave Kayonga some new clothes.
 - Imana guided Kayonga through the forest.
 - Imana replaced Kayonga's fallen teeth.
30. What did Imana order Kayonga to do?
- To avoid smiling at anyone.
 - To be happy all the time.
 - To marry a man named Esiroma.
 - To avoid shedding tears at all times.
31. When Kayonga's stepmother saw the beautiful clothes and jewellery
- she was curious and wanted to know the source.
 - she was jealous and accused Kayonga of theft.
 - she was surprised and wished Kayonga was her real daughter.
 - she was worried and started asking Kayonga many questions.
32. The words 'paid attention to' in the story could be replaced by
- wanted to hear.
 - mad a move.
 - listened eagerly.
 - remembered well.
33. Which of the following words would mean the same as 'puzzled'?
- excited
 - frightened
 - terrified
 - confused
34. Kayonga's two sons died because
- they became sad since their mother was never happy with them.
 - they were secretly poisoned by Kayonga's jealous stepmother.
 - they got frightened to death by their grandmother's threats.
 - they refused to eat unless Kayonga smiled at them.
35. As a reward for Kayonga's obedience, Imana
- changed her into a beautiful girl and gave her new clothes and jewellery.
 - allowed her to smile again and brought her two sons back to life.
 - gave her a beautiful daughter and granted her all the wishes she had.
 - cured her illness and helped her to live happily with her husband and children.
36. What major lesson do we learn from Kayonga's experience?
- when we are faced with trouble, we should act wisely.
 - when we obey, good things will come our way.
 - we should be brave enough to pursue our goals in life.
 - we should pray seriously for the things we need.
37. What do we learn from what finally happens to Kayonga's stepmother?
- Patience pays in the end.
 - Blood is thicker than water.
 - Evil is paid with evil.
 - Prayer solves everything.
38. Which of the following would be the **best** title for this story?
- Kayonga's evil stepmother
 - Kayonga's happy life
 - Kayonga smiles again
 - Kayonga marries Esiroma

Read the following passage and then answer questions 39 to 50.

Accidents happen every day. A family's house catches fire and burns to the ground. Cars and buses collide or overturn. These bad events bring losses to those involved. But the losses can be reduced if people think about these bad events before they happen and prepare for them. This can be done by means of insurance.

Insurance refers to an agreement in which a person pays a company regular amounts of money and the company agrees to pay for losses that may happen. The document which contains the agreement is called an insurance policy. A person who wants to insure his house against fire, for example, goes to an insurance company. He says how much money his house is worth. If the company agrees that this is the correct value, it will insure the house against fire, provided that the person pays a certain sum of money every year. This payment is called a **premium**. If the house does not burn, that money remains with the company. But if a fire breaks out and destroys the house, the company pays the owner a sum of money equal to the value of the house.

Another common type of insurance is motor vehicle insurance. The law says that every vehicle in Kenya has to be insured. The law, however, only insists on the kind of insurance that covers other people who may be involved in accidents with the insured vehicle. This is called third-party insurance. If a vehicle owner wants, he may also insure the vehicle itself, so that if it is stolen or destroyed in an accident, he will be paid by the insurance company some money to buy a new one. This is known as comprehensive insurance.

Apart from insuring property, one can also insure his or her health. This means the insurance company agrees to pay the person's medical bills in case of illness. Because of the high cost of medical care today, this kind of insurance has become quite common. Many employers now insure the health of their workers because they know how important it is to have a healthy staff.

Not all kinds of insurance are aimed at protecting us from **unforeseen** losses. There are some types of insurance that are meant to make it easier to manage some responsibilities. For example, there is education insurance. This involves an agreement in which a person pays a regular amount of money for a period of time. The company then pays the agreed amount to cater for the education of the person's children. This has been found to be an easier way of paying for education.

There is also life insurance. Here, the company pays an agreed amount of money to the family of the insured person when he dies. This money is meant to take care of the people left behind because it is assumed that the death causes loss of financial support. These days, there are even insurance policies which pay for funeral expenses when the insured person dies.

The whole idea behind insurance is to reduce the impact of financial loss or to make it easier to pay for the expenses. It is not meant to make the person insured rich; nor is it meant to stop people from facing bad events or going through the pain of loss. For property insurance, the cause of the loss or destruction should be beyond the control of the property owner. One cannot be paid for destroying their own property. Because of its many benefits, more and more people are taking insurance today.

39. Which of the following is **true** about insurance?
- It helps reduce incidences of fire and accidents.
 - It helps reduce financial losses when accidents happen.
 - It makes people think about dangers at all times.
 - It makes people become more careful about life.
40. People who take insurance may be described as
- fearful.
 - confident.
 - hopeless.
 - careful.
41. Which of the following statements best describes a 'premium'?
- An amount of money that a person gets from an insurance company.
 - An amount of money one pays to a company in order to get insured.
 - An amount of money paid to a person if he or she gets a loss.
 - An amount of money that remains with the company after it pays for losses.
42. Which of the following statements is **not** true about insurance of houses against fire?
- The company and the house owner must agree on the value of the house.
 - The company can only insure the house if the owner pays the premiums as agreed.
 - The company will pay for loss if the house burns, regardless of the cause of fire.
 - The company will keep the premium if the house does not get burned.
43. If an insured four-roomed, two storey building valued at three million shillings gets burned, how much money will the owner get from the insurance company?
- Four million shillings.
 - Three million shillings.
 - Two million shillings.
 - One million shillings.
44. How does an insurance company make money?
- By evaluating the correct value of a house.
 - By telling vehicle owners to take comprehensive insurance.
 - By avoiding to pay all the money claimed.
 - By retaining premiums when losses do not occur.
45. If a car with third-party insurance accidentally hits a pedestrian and gets damaged, who will the insurance company compensate?
- The pedestrian only.
 - The owner of the car only.
 - The one who sold the car.
 - The car owner and the pedestrian.
46. Why do many employers now insure the health of their workers?
- They want to have healthy workers.
 - Health insurance has become quite common.
 - Workers fall ill too often these days.
 - Medical care has become very costly.
47. The word 'unforeseen' means the same as
- mysterious.
 - strange.
 - new.
 - accidental.
48. Why is it important to have education insurance?
- It enables children to do well in school.
 - It makes education less expensive for parents.
 - It makes it easier to meet school expenses.
 - It enables people to achieve success in life.
49. Life insurance helps the family of the insured person when he dies by
- ensuring the family does not feel too sad.
 - making sure that the family lacks nothing.
 - taking care of the duties of the dead person.
 - giving financial support to the family.
50. Which of the following would be the **best** title for this passage?
- Risks of insurance
 - How insurance works
 - Insuring against fire
 - When to take insurance

6.0 ENGLISH SECTION B: COMPOSITION HEARING IMPAIRED

THE KENYA NATIONAL EXAMINATIONS COUNCIL
Kenya Certificate of Primary Education

502 HI

— ENGLISH —
SECTION B: COMPOSITION
HEARING IMPAIRED
Oct. 2019 – 50 minutes



YOUR INDEX NUMBER	
YOUR NAME	
NAME OF YOUR SCHOOL	

READ THESE INSTRUCTIONS CAREFULLY

1. In the spaces provided above, write your full Index Number, your Name and the Name of your School.
2. Now open this paper, read the composition subject carefully and write your composition on the lines provided.
3. The composition **must** be written in English.

This question paper consists of 4 printed pages.



909502 HI

© 2019 The Kenya National Examinations Council
502 HI



Turn over

7.0 KISWAHILI SEHEMU YA KWANZA: LUGHA

THE KENYA NATIONAL EXAMINATIONS COUNCIL
Kenya Certificate of Primary Education

504

— KISWAHILI —
SEHEMU YA KWANZA
LUGHA



Oct. 2019 Muda: Saa 1 dakika 40

MAAGIZO KWA WATAHINIWA (Soma maagizo yafuatayo kwa makini.)

1. Umepewa kijitabu hiki cha maswali na karatasi ya kujibia. Kijitabu hiki kina maswali 50.
2. Ukiisha kuchagua jibu lako, lionyeshe katika **KARATASI YA MAJIBU** na wala **sio** katika kijitabu hiki cha maswali.

JINSI YA KUTUMIA KARATASI YA MAJIBU

3. Tumia penseli ya kawaida.
4. Hakikisha ya kwamba karatasi ya majibu uliyopewa imejumuishwa yafuatayo:
NAMBA YAKO YA MTHANI
JINA LAKO
JINA LA SHULE YAKO
5. Usitie alama zozote nje ya visanduku.
6. Iweke safi karatasi yako ya majibu na usiikunje.
7. Kwa kila swali 1–50 umepewa majibu **manne**. Majibu hayo yameonyeshwa kwa herufi A, B, C, D. Ni jibu **MOJA** tu kati ya hayo manne ambalo ni sahihi. Chagua jibu hilo.
8. Kwenye karatasi ya majibu, jibu sahihi lionyeshe kwa kuchora kistari katika kisanduku chenye herufi uliyochagua kuwa ndilo jibu.

Mfano:

Katika kijitabu cha maswali:

21. Chagua jibu lenye ala za muziki pekee.
- A. filimbi, udi, myukuto, chapuo.
 - B. njuga, tari, kinubi, fidla.
 - C. harimuni, marimba, msondo, maleba.
 - D. siwa, zezze, upatu, nembo.

Jibu sahihi ni **B**.

Katika karatasi ya majibu:

21 [A] [B] [C] [D]

Katika visanduku vinavyoonyesha majibu ya swali namba 21, kisanduku chenye herufi **B** ndicho kilichochorwa kistari.

9. Chora kistari chako vizuri. Kistari chako **kiwe cheusi** na kisijitokeze nje ya kisanduku.
10. Kwa kila swali, chora kistari katika kisanduku **kimoja tu** kati ya visanduku vinne ulivyopewa.

Kijitabu hiki cha maswali kina kurasa 7 zilizopigwa chapa.



909504

© 2019 The Kenya National Examinations Council

504



Geuza ukurasa

Soma vifungu vifuatavyo. Vina nafasi 1 mpaka 15. Kwa kila nafasi umepewa majibu manne. Chagua jibu lifaalo zaidi kati ya yale uliyopewa.

Ukarimu ni 1. Mtu 2 na ukarimu 3 kwa misemo kama vile 4. Ukarimu ni 5 ambayo 6 kufunzwa mwanajamii 7.

1. A. tabia ya kuwasaidia wengine bila malipo
B. hali ya kuwatambua walio na malipo
C. mazoea ya kuwaonea wengine huruma wakilipishwa
D. mwenendo wa kuchangisha wanaolipwa
2. A. asingekuwa B. asipokuwa C. asiokuwa D. asikokuwa
3. A. hurejelewa B. hurejeleana C. hurejelea D. hurejeleka
4. A. moyo mzito B. panya wa nyumba C. shingo ngumu D. joka la mdimu
5. A. maarifa B. stadi C. maadili D. nasaha
6. A. yanastahili B. inastahili C. zinastahili D. unastahili
7. A. wowote B. yeyote C. lolote D. yoyote

8 na Kani katika kidato cha kwanza. Kani alikuwa 9 wanafunzi bora 10 kuona. Hakukata tamaa hata 11 masomoni. Kani alikuwa rafiki wa dhati. Alinisaidia 12 aina za maneno kama vile 13 ambayo ni vivumishi. Pia alinifunza kutenga silabi katika maneno mbalimbali. Kwa mfano, neno 'nywesheana' lina silabi 14. Aidha, aliniambia kwamba umoja wa sentensi, 'Mazulia hayo yao yalifumwa na washonaji wale,' ni: 15.

8. A. Nimekutana B. Ningekutana C. Nilikutana D. Nikakutana
9. A. miongoni mwa B. mkabala mwa C. baadhi ya D. mithili ya
10. A. niliyewahi B. niliowahi C. aliowahi D. aliyewahi
11. A. alipoharibikiwa B. alipoharibiwa C. alipoharibikia D. alipoharibia
12. A. kumfunza B. kujifunza C. kutufunza D. kuwafunza
13. A. sana, nene, fupi, kama
C. kijanja, tano, langu, leo B. nyingine, ajabu, mwenyewe, kisha
D. kadha, yule, chungu, lote
14. A. 5 B. 6 C. 4 D. 3
15. A. Zulia hilo lao lilifumwa na washonaji wale
B. Mazulia hayo yao yalifumwa na mshonaji yule
C. Zulia hilo lake lilifumwa na mshonaji yule
D. Mazulia hayo yake yalifumwa na washonaji wale

Kutoka swali la 16 mpaka 30, chagua jibu sahihi.

16. Maneno yafuatayo yanafuatana vipi katika kamusi?
(i) shtaka (ii) somea (iii) sinia (iv) sebule
A. iv, i, ii, iii,
B. iv, ii, i, iii,
C. iv, iii, i, ii
D. iv, i, iii, ii
17. Ni jibu lipi lenye mpangilio sahihi wa aina za maneno katika sentensi ifuatayo?
Wanafunzi hawa ni hodari kuliko wengine.
A. nomino, kivumishi, kitenzi, kivumishi, kihusishi, kiwakilishi;
B. nomino, kitenzi, kiwakilishi, kivumishi, kihusishi, kivumishi;
C. nomino, kielezi, kitenzi, kivumishi, kiunganishi, kiwakilishi;
D. nomino, kielezi, kitenzi, kihusishi, kiunganishi, kivumishi.
18. Ni jibu lipi lisiloambatanishwa ipasavyo?
A. koo jimbi
B. mjomba halati
C. shaibu buda
D. mavyaa bavyaa
19. Chagua jibu lenye kivumishi kilichoundwa kutokana na kitenzi.
A. ita – mwito
B. saha – sahaulifu
C. agiza – maagizo
D. vumilia – uvumilivu
20. Ni sentensi ipi inayoonyesha kusudi la tendo?
A. Suna aliingia zizini akawafungulia ng'ombe, akaculeka malishoni.
B. Malika alitambua wende tukavue samaki.
C. Wafanyakazi walifanya bidii wakamaliza kazi hiyo.
D. Wageni watakuja watakapokamilisha shughuli.
21. Sentensi, 'Sauna aliwafanya Siki na Patu waandike insha,' inamaanisha;
A. Sauna aliwaandikisha Siki na Patu insha.
B. Sauna aliwaandikishia Siki na Patu insha.
C. Siki na Patu walimwandikia Sauna insha.
D. Siki na Patu waliandikia insha kwa Sauna.
22. Chagua jibu lenye viambishi vya neno: funguliana.
A. fu-a-na
B. li-an-a
C. fu-an-a
D. li-a-na
23. Chagua sentensi iliyoafikishwa ipasavyo.
A. Vifaa vyote – vile vilivyoagizwa jana – vimeletwa.
B. Lo, hilo kubwa hivyo, utaliweza?
C. Magunia haya hayatoshi! tutanunua mengine.
D. Mweka hazina (aliyeteuliwa) hapa jana ni (mwenye) bidii.
24. Ni sentensi ipi iliyo katika hali timilifu?
A. Magari hayapiti hapa siku hizi.
B. Mitaro hiyo haijachimbwa vyema.
C. Nguo yake haikuoshwa ipasavyo.
D. Wimbo hautaimbisha na kiongozi.
25. Onyesha sentensi iliyounganisha sentensi zifuatazo ipasavyo.
Makaa alijaribu kuliokoa dau hilo.
Makaa hakufaulu.
A. Mithili ya Makaa kujaribu kuliokoa dau hilo, hakufaulu.
B. Licha ya Makaa kujaribu kuliokoa dau hilo, hakufaulu.
C. Makaa alijaribu kuliokoa dau hilo madhali hakufaulu.
D. Makaa alijaribu kuliokoa dau hilo walau hakufaulu.
26. Chagua sentensi yenye kivumishi kiulizi.
A. Leo wameapishwa wangapi?
B. Wasusi, wanaculeka wapi?
C. Huyu atavikwa pete gani?
D. Mashubaka haya yalitengenezwa lini?
27. Methali "Fimbo ya mbali haiui nyoka" huambiwa mtu anayetegemea walio mbali kutatulia matatizo yake. "Kiserema hulima kikashinda jembe zima," huambiwa:
A. Mtu anyejiona kuwa maarufu sana katika jambo kuliko wengine.
B. Mtu anyeziona hali za wengine kuwa za kawaida kuliko zao.
C. Mtu anayedharau matatizo yake kuliko ya wengine.
D. Mtu anayepuza makubaliano ya wengine kuliko yao.
28. Chagua usemi wa taarifa wa sentensi ifuatayo. "Shule zitafunguliwa lini?" Yohana akauliza.
A. Yohana alitaka kujua wakati ambapo shule zingefunguliwa.
B. Yohana aliuliza ikiwa shule zitafunguliwa.
C. Yohana aliuliza wakati ambapo shule zinafunguliwa.
D. Yohana alitaka kujua ikiwa shule zingefunguliwa.
29. Ikiwa juzi ilikuwa Jumanne, mtondo itakuwa:
A. Ijumaa
B. Jumapili
C. Jumamosi
D. Jumatatu
30. Akisami, $\frac{3}{8}$ kwa maneno ni:
A. sudusi tatu
B. thuluthi nane
C. tusui nane
D. thumni tatu

Soma kifungu kifuatacho kisha ujibu maswali 31 mpaka 40.

Msemu, “Vijana ndio viongozi wa kesho”, hutolewa na wengi bila kuwazia maana yake. Hata hivyo, ni dhahiri kwamba mtu **anapoupigia darubini** msemu huu, utamwelekeza kugundua kuwa vijana ni mbegu ambayo inahitaji kupaliliwa ili kukifaa kizazi chao na cha siku za usoni. Tunaposema kwamba vijana ni viongozi wa kesho, tunamaanisha kwamba vijana ndio wanaotarajiwa kuchukua usukani wa kuidhibiti jamii yao wakati utendakazi wa watangulizi wao unapofikia kikomo kutokana na umri au maradhi.

Ni muhimu kujiuliza, “Ni kwa vipi vijana wanaweza kuwa tegemeo la kesho?” Kwanza kabisa, ibainike kwamba vijana, kwa sababu ya umri wao mbichi, wana mifupa myepesi, hivyo utendakazi wao huwa bora kuliko wa watu wa makamo au wale waliobugia chumvi nyingi. Isitoshe, kwa sababu ya bongo zao kuwa changa, vijana huweza kujifunza kwa urahisi mbinu mpya na bora za kuendeleza nchi. Bila shaka ukitazama katika mazingira yako, unapata kwamba aghalabu vijana ndio wenye ustadi wa hali ya juu katika kutumia teknolojia ya kisasa. Hali hiyo inachangia kuimarisha ubunifu na kuboresha hali ya maisha. Sijui kama unafahamu kwamba ile huduma ya simu almaarufu MPESA ambayo imeifanya Kenya kutia fora kitaifa na kimataifa ilibuniwa na kijana.

Hali kadhalika, vijana wana nafasi kubwa katika kuendeleza maaadili na mshikamano wa kijamii. Kundi hili lina ushawishi mkubwa kwa raia. Kwa vile vijana ndio wengi nchini, wanaweza kuifikia asilimia kubwa ya raia na kuiathiri, ama kwa njia hasi, au chanya. Si ajabu kupata kwamba mizozo mingine nchini, japo huenda inazuliwa na wazee, hupaliliwa na kuendelezwa zaidi na vijana waliopotoshwa na wazee hawa. Isitoshe, kwa vile vijana wanaaminiana na kuthaminiana sana, wao wanaweza kusaidia kubadili mienendo ya wenzao. Ukichunguza katika jamii unamoishi, utapata kwamba vijana wengi huhitari kuwafichulia wenzao siri zao badala ya wazazi wao. Hili labda husababishwa na tofauti za kiumri na kimtazamo kati ya vijana na wazazi, au kile vijana **wanachokiita**, **‘ukali wa wazazi’**. Kwa sababu ya kuaminiana kwa vijana, utapata kwamba vijana wengi wameweza kuwashauri wenzao dhidi ya kuchukua hatua zisizo za busara kama vile kujiingiza katika ndoa za mapema, kushiriki mapenzi kiholela na hata kujitia kitanzi.

Umuhimu wa vijana hauwezi kupuuzwa. Licha ya kwamba wao ndio wanotarajiwa kukiendeleza kizazi cha jamii yao, wao ndio wanorithishwa desturi za jamii yenyewe ili kuziendeleza. Ni jukumu la wanajamii kuhakikisha kwamba wamewatayarisha vijana kukabiliana na majukumu yao. Jamii haina budi kuhakikisha kwamba asilimia kubwa ya vijana imepata elimu ili kupata stadi za kuzalisha mali na kuendeleza uongozi ufaao. Kadhalika, ni muhimu kuhakikisha kwamba vijana hawabakii tu kuwa viongozi wa kesho katika kauli na maandishi yetu. Washirikishwe katika uongozi wenyewe wakiwa wadogo ili ifikapo wakati wa kuzichukua nyadhifa za ngazi za juu waweze kuzimudu ipasavyo. Wanaotumia msemu, ‘Viongozi wa kesho’ kumaanisha kwamba vijana hawana nafasi katika uongozi wa sasa nao waonywe dhidi ya haya. Wakumbushwe kuwa iwapo watang’ang’ania kubaki uongozini hata wanapofikia umri wa kustaafu, wanaendelea kuua ari ya vijana ya kuwajibikia uongozi wa jamii yao.

31. Kulingana na kifungu, vijana ndio viongozi wa kesho kwani wao:
- wakiheshimiwa vizuri wataweza kuanzisha kizazi kijacho;
 - wakitayarishwa vyema wanaweza kuiletea jamii neema baadaye;
 - wakitambuliwa ipasavyo wanaweza kuifahamisha jamii faida yao baadaye;
 - wakiamuliwa ipasavyo, wanaweza kuandaliwa mamlaka yajayo.
32. Aya ya **kwanza** imeonyesha kwamba:
- Umri na hali ya afya ya mtu huathiri matokeo ya kazi yake.
 - Kutokuwepo kwa vijana hupunguza matumaini ya kurithi mamlaka.
 - Kutowafikiria vijana hudhoofisha uongozi unaotangulia.
 - Unyonge wa mwili huathiri kubadilishana kwa zamu kazini.
33. Katika jamii yenye watu wachanga:
- Njia mpya za kukabiliana na umri hustawishwa.
 - Udumishaji wa teknolojia ya kisasa huwa maarufu.
 - Mikakati bora ya kufanikisha maendeleo huanzishwa.
 - Hali ya kubuni mitandao huwa ya kimataifa.
34. Kulingana na aya ya **tatu**:
- Mizozo ya wazee waliopotoka hutangazwa zaidi na vijana.
 - Vijana hufichua siri za wengine kuliko wazazi wao.
 - Kuaminiana miongoni mwa vijana huwafanya wengine wasiuawe.
 - Vijana ndio wanaoweza zaidi kuendelea matendo mema katika jamii.
35. Vijana wanaweza kuleta mapinduzi yafaayo nchini kwa vile:
- Mizozo inapoanzishwa wao huwa na ushauri tofauti.
 - Siri zinapotokea nyumbani wao huwafichulia wenzao.
 - Wanapendana na kujitambulisha na kila mmoja wao.
 - Wanafunzana na kuelewa tofauti za wazazi wao.
36. Chagua jibu **lisilo sahihi** kwa mujibu wa kufungu: Vijana:
- wanawaogopa wazazi wao kwa vile watu wanajua ni wakali;
 - huwaficha wazazi mambo kwa sababu ni wa kizazi kingine;
 - wanachangia katika utoaji nasaha katika jamii;
 - wanaweza kubadilisha na kuyaokoa maisha ya wenzao.
37. Mwandishi ameonyesha kwamba vijana ndio:
- wanaopaswa kuanzisha elimu ya jamii;
 - wanaopitisha matendo na imani za jamii;
 - wanaotarajiwa kuhusiana na vizazi;
 - wanaowaonyesha mbinu za kutafuta mali kwao.
38. Kulingana na aya ya mwisho kufanikiwa kwa vijana kumategemea:
- kupewa majukumu ya uongozi wakiwa wachanga;
 - muda wanaochukua kufunzwa uongozi na jamii;
 - kustaafu uongozini kwa wazee wenye busara;
 - hamu wanayopata baada ya kuchukua uongozi.
39. Chagua maana ya '**anapoupigia darubini**'.
- anapousisitiza kwa uaminifu.
 - anapouelewa kwa dhati.
 - anapoufafanua kwa mapana.
 - anapouchunguza kwa kina.
40. **Wanachokiita 'ukali wa wazazi'** ina maana kwamba mwandishi:
- anakana kuwa wazazi ni wakali;
 - anahofia kuwa wazazi ni wakali;
 - anadai kuwa wazazi ni wakali;
 - ameamini kuwa wazazi ni wakali.

Soma kifungu kifuatacho kisha ujibu maswali 41 mpaka 50.

Kisa kuhusu shughuli ya wanyama kuchimba kisima husimuliwa kwa msisimko mkubwa katika jamii nyingi. Inasemekana kuwa wanyama, wakiongozwa na mfalme wao Simba, walikuwa wakiishi kwa amani na ushirikiano. Siku hizo, shida za mnyama mmoja zilikuwa za wanyama wote. Wale waliokuwa maskini walisaidiwa kwa chakula. Wale ambao walikuwa wenye tamaa kama vile Fisi hawakusita kuonywa dhidi ya kutamani vya wengine. Wale waliokuwa watepetevu na wenye hila kama Sungura nao walishauriwa kuchanika kwenye mpini. Alimradi kila mnyama alijifunga masombo kujenga jamii yenye utu na ustawi.

Hali iliendelea kuwa shwari, jamii ya wanyama ikijitosheleza kwa chakula msimu baada ya mwingine hadi mvua ilipogoma kunyesha. Ukame mkubwa ulijiri; ardhi na mimea ikakauka, wanyama na makinda wao wakawa katika hatari ya kupukutishwa na njaa pamoja na jua lililowaka kama tanuri. Baada ya kuwaza na kuwazua, Simba alitisha mkutano wa wanyama ili washauriane kuhusu namna ya kukabiliana na hali ambayo ilikuwa tayari kukiangamiza kizazi cha wanyama.

Mkutano ulianza saa tatu asubuhi. Kila mnyama alijihimu kufika mapema. Kobe na Sungura ndio waliokuja wamechelewa kama desturi. Basi baada ya kusafisha koo, Simba alisema, “Ndugu zangu, nimewaita hapa ili kujadiliana kuhusu jinsi tunavyoweza kukabiliana na hali ya ukame na njaa iliyotukumba. Ingawa maghala yetu bado yana nafaka, hali hii ya ukame ikiendelea, mifugo wetu watakufa.”

Kila mnyama alitoa maoni yake. Hatimaye walifikiana kwamba wachimbe kisima kwa zamu ili wapate maji ya kunywa na kunyunyizia mimea. Simba alimwomba Nyumbu aandike ratiba ya jinsi kazi itakavyoendelea. Alisema pia kwamba ikiwa katika siku ya kwanza maji yakatakuwa yamepatikana, basi atakayekuwa ameyapata atatumikiwa zawadi. Kauli hii ilimfanya kila mnyama kutaka kuwa wa kwanza kuchimba. Mabishano makali yalitokea hadi pale Simba mwenyewe alipoamua kwamba ndiye atakayekuwa wa kwanza, kisha afuate Ndovu, Twiga Kifaru... na mwishowe Sungura. Alipotaja jina la Sungura, wanyama, hasa wale wakubwa, walicheka, wakishangaa vipi Sungura na umbo lake dogo atakavyoweza kuutifua udongo kupata maji.

Zamu ya Simba ilifika, akaelekea kulikokuwa kumetengwa kuchimbwa kisima. Alitifua udongo kwa maringo na nguvu zake zote lakini kilichotokea ni vumbi tu. Aliondoka huku amejinamia na kusimama kando. Ndovu alijua kwamba unene wake utamwezesha kutekeleza yale yaliyomshinda Simba. Alijaribu mara ya kwanza, ya pili, ya tatu... matokeo yakawa yale yale ya Simba. Ndovu alishusha pumzi kubwa, akatikisa kichwa na kuondoka, akaketi chini ya mti na **kushika tama**. Twiga, Kifaru na Duma walifuata lakini matokeo hayakuwa tofauti na ya wenzao; wote waliigonga ardhi kwa vichwa vyao, wakasalimiwa na vumbi tu.

Sasa ilikuwa zamu ya Sungura. Wanyama walimtazama kwa bezu huku wakijua kuwa Sungura hataweza lolote. Sungura aliinama kando ya mti mmoja mkubwa, akatoa mtaimbo na kuuchomeka kwenye kichwa chake. Wanyama wengine walipomwona **walicheka hadi mbavu zikavunjika**. Sungura aliitalii ardhi kwa makini kabla hajaanza kuichimba kwa mtaimbo uliokuwa kichwani mwake. Baada ya dakika kumi za kuchimba, milizamu ya maji ilijitokeza ghafla na kuwalovya wanyama wote. Ardhi sasa ilijaa unyevu, mimea ikaanza kuchipuka mara moja. Wanyama walimtazama Sungura kwa mshangao mkuu. Hakuna aliyenena lolote, wote waliinamisha nyuso chini. Sungura alichukua kipaza sauti na kusema kwa fahari kuu, “**Ndugu zangu, wakati wa vita wale wanaonusurika si walio na silaha kali bali wale wanaojua namna na wakati wa kuzitumia silaha hizo**”.

41. Kulingana na aya ya **kwanza**, wanyama:
- waliishi kwa amani kutokana na uongozi wa Simba;
 - walijali masilahi ya wale waliokuwa wanyonge;
 - walishangazwa na wanyama waliotamani vitu;
 - walichangamkia hadithi zilizohusu kuboresha hali zao.
42. Maendeleo katika jamii ya wanyama yalitokana **hasa na:**
- kuwapa nasaha waliokuwa na matatizo;
 - kuwaonya wanyama wenye ubinafsi;
 - uwajibikaji wa pamoja wa wanyama;
 - uelekezaji wa wale wasiotia bidii.
43. Chagua athari za ukame kwa mujibu wa aya ya **pili**.
- kiangazi kikali, hofu ya kupoteza uhai;
 - kukauka kwa mito, kutaabika kifikira;
 - kuongezeka kwa joto, kutojitosheleza kwa lishe;
 - kupotea kwa makinda, wanyama kusikitika.
44. Kulingana na kifungu, ni kawaida kwa:
- Simba kuomba maoni ya wanyama;
 - Sungura kufika baada ya muda uliokubaliwa;
 - Wanyama kufurahia akiba ya nafaka;
 - Mifugo kuuawa wakati wa kiangazi.
45. Aya ya **nne** imebainisha kwamba:
- Kutamani kuwa bingwa kunaweza kuzua utengano.
 - Kutarajia kumaliza kwanza kunaweza kuleta kutoelewana.
 - Kutegemea kufanikiwa maishani kunaweza kuonyesha kufarakana.
 - Kutaka kupata faida kunaweza kusababisha ugomvi.
46. Kwa nini wanyama walicheka?
- Jina la Sungura liliwakumbusha kupuuza kazi kwake.
 - Kimo cha Sungura kilidhaniwa na wanyama kuwa udhaifu.
 - Kuja mwishoni kwa Sungura kungezuia kupatikana kwa maji.
 - Kustaajabisha kwa Sungura kulionyesha uwezo wa wanyama wakubwa.
47. Kifungu kimebainisha kwamba:
- Jambo likifanywa na wanaowazia majivuno hutatizika.
 - Jambo likitendwa kwa kuwaiga wengine huonyesha kinyume.
 - Jambo likiwckewa mikakati ifaayo huwa na matokeo yaliyotarajiwa.
 - Jambo likishughulikiwa bila kuharakishwa huleta mabadiliko mema.
48. **“Ndugu zangu, wakati wa vita wale wanaonusurika si walio na silaha kali bali wale wanaojua namna na wakati wa kutumia silaha hizo”.**
Chagua methali inayoweza kujumuisha ujumbe wa kauli hii.
- Makaa hayaoki nyama.
 - Kisu kibutu hakichinji kuku.
 - Jina la sifa huletwa na matendo.
 - Chombo imara hustahimili mawimbi makali.
49. **“Walicheka hadi mbavu zikavunjika”**, imetumia tamathali gani ya usemi?
- chuku
 - sitari
 - nahau
 - ishara
50. Chagua maana ya **‘kushika tama’** kwa mujibu wa kifungu.
- kuhuzunika
 - kunung’unika
 - kukasirika
 - kuhangaika

8.0 KISWAHILI SEHEMU YA PILI: INSHA

THE KENYA NATIONAL EXAMINATIONS COUNCIL
Kenya Certificate of Primary Education

505

— KISWAHILI —
SEHEMU YA PILI
INSHA

Oct. 2019 – Muda: Dakika 40



NAMBA YAKO YA MTIHANI	
JINA LAKO	
JINA LA SHULE YAKO	

SOMA MAAGIZO YAFUATAYO KWA MAKINI.

1. Kwenye nafasi zilizoachwa hapo juu, andika Namba yako kamili ya mtihani, Jina lako na Jina la Shule yako.
2. Sasa geza ukurasa huu. Soma kichwa cha insha kwa makini kisha uandike insha yako kwenye nafasi ulizoachiwa.
3. Insha **lazima** iandikwe kwa lugha ya Kiswahili.

Kijitabu hiki kina kurasa 4 zilizopigwa chapa.



909505

© 2019 The Kenya National Examinations Council

505



Geza ukurasa



KCPE 2019

KENYAN SIGN LANGUAGE SECTION A: LANGUAGE USE

Time: 1 hour 40 minutes

INSTRUCTION BELOW READ CAREFUL CAREFUL

1. BOOKLET THIS HAVE QUESTION 50/ THERE HAVE ANOTHER PAPER FOR ANSWER WRITE ONLY//
2. TIME ANSWER CORRECT HAVE/WRITE/PAPER OTHER//ANSWER CORRECT/WRITE BOOK THIS NO//
3. TIME WRITE ANSWER THIS/PENCIL USE ONLY//
4. PAPER OTHER FOR ANSWER CHECK HAVE MUST/
 - INDEX NUMBER YOUR//
 - NAME YOUR//
 - NAME SCHOOL YOUR//

5. WRITE ANSWER WELL/OUTSIDE BOX NO//
6. TIME ANSWER WRITE/MAKE LINE USE PENCIL SHOW ANSWER CORRECT YOU CHOOSE WHICH//

EXAMPLE: PAPER QUESTION

16. FLAG KENYA COLOUR _____ HAVE//

a) 5	c) 4
b) 8	d) 3

PAPER ANSWER:

16. a) b) c) d)

7. ANSWER CORRECT MUST WRITE SHOW COLOUR BLACK CLEAR//
8. ANSWER EACH MUST BOX ONE ONLY COLOUR//
9. PAPER ANSWER MUST CLEAN STAY SAME FOLD NO//
10. QUESTION 1-50 THERE/ANSWER ALL QUESTION 1-50//



909501S

BOOK THIS HAVE PAGE 9 SAME HAVE WORD PRINT PRINT THERE// CHECK PAGE 9 ALL NOW//
© 2019 The Kenya National Examinations Council



PAGE TURN

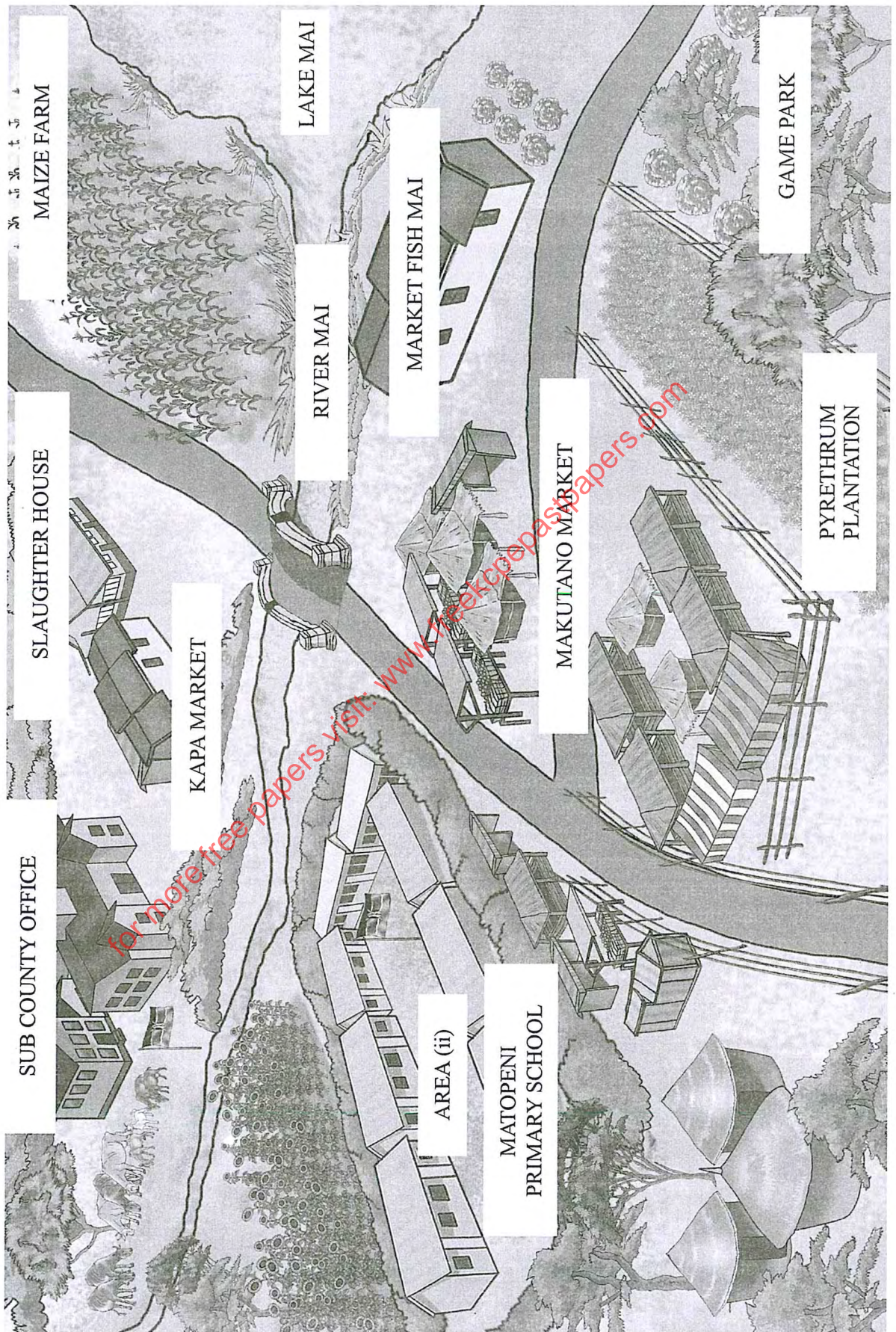

OBSERVE PICTURE THIS SAME USE ANSWER QUESTION 1-10 CORRECT!!

1. PICTURE THERE SHOW AREA THING

NOTHING WHICH?

- a] LIVESTOCK KEEP//
- b] RIVER HAVE//
- c] FOREST HAVE//
- d] CAMEL KEEP//

2. STATEMENT TRUE AREA THIS WHICH?

- a] PEOPLE BUSINESS FEW//
- b] PEOPLE BEE KEEP//
- c] MARKET HAVE MANY//
- d] ROAD 3 HAVE//

3. PICTURE THERE AREA (ii) PEOPLE WORK

SAME THERE WHO?

- a] TEACHER//
- b] DOCTOR//
- c] MECHANIC//
- d] NURSE//

4. AREA THIS PLACE MEAT SELL WHICH?

- a] SCHOOL MATOPENI//
- b] OFFICE COUNTY//
- c] SLAUGHTER HOUSE//
- d] DIRECTOR FARM//

5. GAME PARK IMPORTANT WHY?

- a] ANIMAL GRAZE//
- b] ANIMAL PRESERVE//
- c] ANIMAL HUNT//
- d] TOURISM ANIMAL//

6. AREA ACTIVITY ECONOMIC HAPPEN

NOTHING WHICH?

- a] ANIMAL KEEP//
- b] FARM CULTIVATE//
- c] BEE KEEP//
- d] FISH CATCH//

7. AREA THIS FARMER PLANT CROP

NOTHING WHICH?

- a] PYRETHRUM//
- b] MAIZE//
- c] SUNFLOWER//
- d] COFFEE//

8. PICTURE THIS MARKET FISH WHICH?

- a] MAKUTANO//
- b] MATOPENI//
- c] KAPA//
- d] MAJI//

9. ACTIVITY HAPPEN AREA THIS

NOTHING WHICH?

- a] ANIMAL KEEP//
- b] MAIZE FARM//
- c] FISH CATCH//
- d] TREE CUT//

10. AREA GOVERNMENT OFFICER THERE

PERSON RESPONSIBLE WHO?

- a] CHIEF//
- b] DIRECTOR SUB-COUNTY//
- c] DIRECTOR COUNTY//
- d] GOVERNOR//

SIGN SIGN BELOW OBSERVE/QUESTION

11-15 ANSWER CORRECT//

11. SIGN THIS MEAN WHAT



- a] CONNECT//
- b] SAD//
- c] SHOCK//
- d] ANGRY//

12. SIGN THIS MEAN WHAT?



- a) COIN//
- b) TAX//
- c) NAME//
- d) DIGITAL//

13. SIGN THIS MEAN WHAT?



- a) MOUTH//
- b) LIP//
- c) TONGUE//
- d) TEETH//

14. SIGN BELOW DIRECTION DIFFERENT

TIME SIGN WHICH?

- a) LETTER//
- b) POST//
- c) TELEGRAPH//
- d) REGISTER//

15. CORRECT WAY WRITE SIGN THIS WHICH?



- a) ANSWER//
- b) INTERVIEW//
- c) DIALOGUE//
- d) COMMUNICATE//

SENTENCE 16-17 BELOW PUNCTUATION USE CORRECT WHICH?

- 16. a) TIME MARKET GO SUKUMA YOU BUY//
- b) TIME MARKET GO SUKUMA/YOU BUY//
- c) TIME/MARKET GO SUKUMA YOU/ BUY//
- d) TIME MARKET GO/SUKUMA YOU BUY//

- 17. a) IF ME CLOTH MANY HAVE/ORPHAN HELP MUST//
- b) IF ME CLOTH MANY HAVE/ORPHAN HELP MUST//
- c) IF ME CLOTH MANY/HAVE ORPHAN HELP MUST//
- d) IF ME CLOTH MANY HAVE ORPHAN/HAVE MUST//

ANSWER QUESTION 18-20 CORRECT//

18. SENTENCE SHOW ACTION HAPPEN PAST WHICH?

- a) CHURCH FLOWER GIRL ENTER FINISH//
- b) CHURCH FLOWER GIRL ENTER AT WILL//
- c) CHURCH FLOWER GIRL ENTER NEVER//
- d) CHURCH FLOWER GIRL ENTER MUST//

19. SENTENCE BELOW CORRECT ACTION HAPPEN FUTURE WHICH?

- a) NOW DOCTOR PATIENT TREAT//
- b) DOCTOR PATIENT TREAT FINISH//
- c) DOCTOR PATIENT TREAT TOMORROW//
- d) DOCTOR PATIENT FINISH TREAT FUTURE//

20. SENTENCE BELOW CORRECT PLURAL SHOW WHICH?

- a) BOY ONE BREAD EAT//
- b) BOY BOY BREAD EAT//
- c) BOY THIS BREAD EAT//
- d) BOY BREAD EAT//

for more free papers visit www.freepapers.com

**PASSAGE BELOW READ/QUESTION 21-25
ANSWER CORRECT//**

T-E-D-D-Y/B-O-B/A-L-I/S-U-E SCHOOL
SAME GO//T-E-D-D-Y YEAR OLD 10/B-O-B
YEAR OLD SAME A-L-I/B-O-B YEAR OLD 4
MORE THAN T-E-D-D-Y//BUT SUE YEAR OLD
3 BELOW T-E-D-D-Y//
B-O-B NOW CLASS 8 BUT CLASS 1 ABOVE
A-L-I/T-E-D-D-Y NOW CLASS 3 BELOW
B-O-B BUT CLASS 2 ABOVE S-U-E//

21. B-O-B SAME A-L-I YEAR OLD WHICH
a] 6//
b] 14//
c] 8//
d] 10//

22. STUDENT CLASS FIVE WHO
a] T-E-D-D-Y//
b] B-O-B//
c] S-U-E//
d] A-L-I//

23. STUDENT TWO CLASS SAME WHO
a] B-O-B/A-L-I//
b] T-E-D-D-Y/A-L-I//
c] S-U-E/T-E-D-D-Y//
d] T-E-D-D-Y/B-O-B//

24. S-U-E YEAR OLD HOW-MANY?
a] 4//
b] 2//
c] 7//
d] 3//

25. A-L-I CLASS WHICH?
a] 3//
b] 4//
c] 7//
d] 5//

**QUESTION 26-30 BELOW ANSWER
CORRECT//**

26. SIGN IMPOSSIBLE SIGN AREA CHEST
WHICH?
a] MINE//
b] OWN//
c] OUR//
d] HIS//

27. SIGN BELOW HAND MOVE UP-DOWN
NOTHING WHICH?
a] WARM//
b] WOMAN//
c] PEACE//
d] PAINT//

28. SIGN BELOW HAND TWO USE
NOTHING WHICH?
a] BROTHER//
b] DAUGHTER//
c] SISTER//
d] WIFE//

29. SIGN BELOW OBSERVE KSL ORDER
CORRECT IDENTIFY//



- a] (iii)/(iv)/(ii)/(i)//
b] (i)/(iii)/(iv)/(ii)//
c] (i)/(ii)/(iv) (iii)//
d] (i)/(ii)/(iii)/(iv)//

30. SENTENCE WHICH SHOW QUESTION
ASK CORRECT//

- a] YOUR WORK WHERE
b] WORK YOU WHERE//
c] WORK WHERE YOU//
d] WHERE YOU WORK//

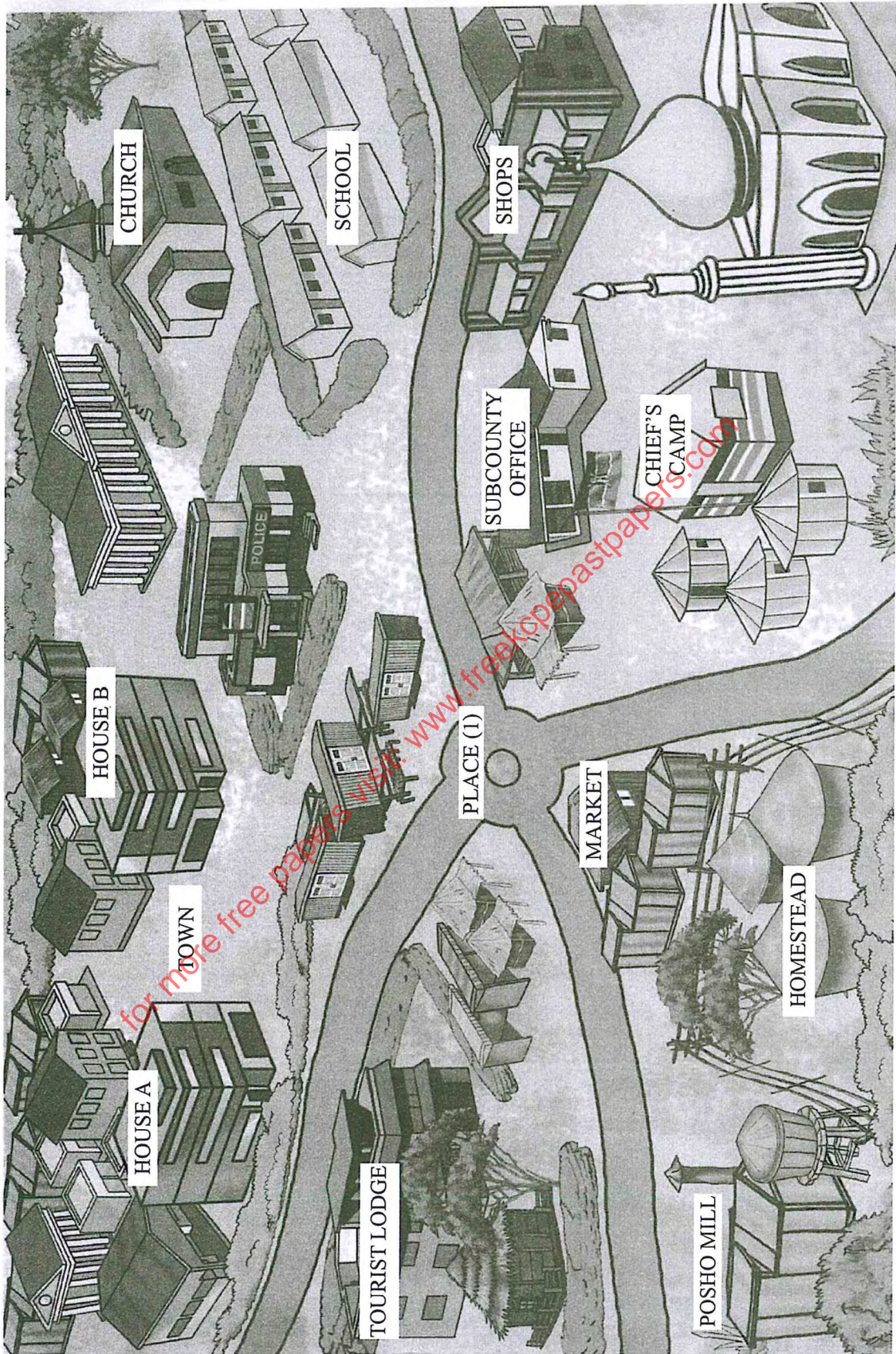

OBSERVE PICTURE THIS SAME USE ANSWER QUESTION 31-40 CORRECT//

31. TIME YOU CHURCH CHIEF CAMP

DIRECTION WHICH?

- a] NORTH//
- b] SOUTH//
- c] EAST//
- d] WEST//

32. PLACE (I) NAME WHAT _____ ?

- a] ROAD JUNCTION//
- b] ROAD BEND//
- c] ROAD CORNER//
- d] ROAD CROSS//

33. SUBCOUNTY EDUCATION OFFICE

ACROSS WHERE?

- a] CHURCH//
- b] SCHOOL//
- c] POLICE STATION//
- d] LAW COURT//

34. TIME YOU TOWN WANT GO POSHO MILL GO HOW?

- a] SOUTH EAST/SOUTH/SOUTH WEST/ SOUTH//
- b] SOUTH/SOUTH WEST/SOUTH/ SOUTH EAST//
- c] SOUTH WEST/SOUTH/SOUTH EAST/ SOUTH//
- d] GO SOUTH/SOUTH/SOUTH EAST/ SOUTH WEST/SOUTH//

35. PICTURE THERE HOUSE A _____ HOUSE B//

- a] NEXT//
- b] SAME//
- c] FAR//
- d] LEFT//

36. TIME YOU STAND SHOP/MOSQUE

DIRECTION WHICH?

- a] NORTH//
- b] SOUTH//
- c] SOUTH EAST//
- d] NORTH EAST//

37. SCHOOL _____ CHURCH//

- a] ABOVE//
- b] ALONG//
- c] FAR//
- d] OPPOSITE//

38. POSHO MILL WORK WHAT _____ ?

- a] FLOUR MAKE//
- b] COFFEE MAKE//
- c] TEA MAKE//
- d] TIMBER MAKE//

39. SENTENCE TRUE PICTURE THIS WHICH _____ ?

- a] SHOP/SUB COUNTY EDUCATION DIRECTION SAME//
- b] TOURIST LODGE/LAW COURT NEAR//
- c] CHIEF CAMP/MOSQUE OPPOSITE//
- d] TOURIST LODGE/POSHO MILL DIRECTION NORTH//

40. SENTENCE TRUE AREA THIS WHICH _____ ?

- a] AREA HAVE CHRISTIAN PEOPLE ONLY//
- b] AREA HAVE CHRISTIAN SAME MUSLIM//
- c] AREA HAVE MUSLIMS ONLY//
- d] AREA HAVE MUSLIM/CHRISTIAN NOTHING//

for more free papers visit: www.freepepastpapers.com

STORY BELOW READ SAME QUESTION

41-50 ANSWER CORRECT GIVE//

TIME YOU HEAD TEACHER OFFICE ENTER/
INFRONT THERE/CHAIR THREE HAVE SAME
CABINET//SIDE LEFT SOFA SET BEAUTIFUL
THERE COVER WELL//HEAD TEACHER
TABLE NEAR/CABIN BIG THERE//SCHOOL
FILE SAME IMPORTANT DOCUMENT THERE
KEEP//SIDE OTHER BOOK-SHELF THERE
HAVE//BOOK DIFFERENT THERE KEEP SAME
NEWSPAPER THERE MANY HAVE//

HEAD TEACHER BUSY ALOT SAME WORK
A LOT//PARENT LOVE HIM A LOT SAME
PUPIL//HIMSELF WANT PUPIL READ READ
GRADE GOOD GET//SELF PEOPLE ADVICE
ALWAYS/READ HARD WORK GOOD//OFFICE
THIS COMPUTER HAVE/HEAD TEACHER
COMPUTER USE//SECRETARY COMPUTER
OTHER USE TIME EXAM TYPE//SAME IF
TEACHER WANT USE CAN//

T-V OFFICE HAVE NOTHING BUT PRINTER
SMALL THERE HAVE/TIME PRINT PAPER
USE//OFFICE THIS CARPET HAVE SAME
FRIDGE HAVE/SODA SAME WATER THERE
KEEP//HEAD TEACHER SODA PUPIL GIVE
NOTHING/VISITOR GIVE ONLY//VISITOR
MANY OFFICE THIS ADMIRE SAME LOVE
STAY-LONG//

909501S

41. HEAD TEACHER OFFICE FRONT THING

TWO SEE WHAT?

- a) CHAIR/SOFA SET//
- b) CHAIR/CABINET//
- c) CABIN/CHAIR//
- d) SOFA SET/CABINET//

42. CABIN BIG HEADTEACHER KEEP WHAT?

- a) NEWSPAPER/DOCUMENT//
IMPORTANT//
- b) SCHOOL FILE/DOCUMENT
IMPORTANT//
- c) BOOK/SCHOOL FILE//
- d) NEWSPAPER/SCHOOL FILE//

43. PARENT HEAD TEACHER LOVE WHY?

- a) WORK A LOT//
- b) LOVE THEM SAME//
- c) OFFICE BEAUTIFUL//
- d) SODA FREE GIVE//

44. COMPUTER OFFICE THERE HOW-MANY?

- a) 1//
- b) 3//
- c) 2//
- d) 4//

45. SODA THERE HEAD TEACHER GIVE

WHO?

- a) PARENT//
- b) PUPIL//
- c) TEACHER//
- d) VISITOR//

46. BOOK/NEW PAPER HEAD TEACHER

KEEP WHERE?

- a) CABIN BIG//
- b) TABLE//
- c) BOOK-SHELF//
- d) CABINET//

47. COMPUTER THERE SECRETARY USE

HOW?

- a) EXAM TYPE//
- b) EXAM KEEP//
- c) SAME TEACHER//
- d) HEAD TEACHER USE//

48. HEAD TEACHER OFFICE THING HAVE

NOTHING WHICH?

- a) PRINTER//
- b) T-V//
- c) COMPUTER//
- d) FRIDGE//

49. SIDE WHICH BOOKSHELF THERE KEEP//

- a] LEFT//
- b] FRONT//
- c] RIGHT//
- d] BEHIND//

50. TITLE BEST STORY THIS WHICH ?

- a] SCHOOL OFFICE//
- b] OFFICE BEAUTIFUL//
- c] VISITOR OFFICE ADMIRE//
- d] OFFICE HEAD TEACHER//

for more free papers visit: www.freekcpastpapers.com

THE KENYA NATIONAL EXAMINATIONS COUNCIL



KCPE 2019

KENYAN SIGN LANGUAGE SECTION B: COMPOSITION

Time: 40 minutes

INDEX NUMBER YOUR	
NAME YOUR	
NAME SCHOOL YOUR	

INSTRUCTION INSTRUCTION BELOW READ CAREFULLY//

1. NAME YOUR WRITE/INDEX NUMBER YOUR SAME NAME SCHOOL YOUR WRITE SPACE ABOVE//
2. PAPER THIS OPEN PICTURE PICTURE THERE OBSERVE WELL THEN COMPOSITION WRITE/



PAPER THIS PAGE PAGE 5 HAVE//

909502S

© 2019 The Kenya National Examinations Council

PAGE TURN





TIME 40 MINUTE USE OBSERVE PICTURE THERE WRITE STORY // STORY YOUR END USE SENTENCE

..... ALL LUCKY LIFE OUR SAVE FINISH//

for more free papers visit: www.freekcpastpapers.com

.....

.....

.....

.....

.....

.....

.....

.....

.....

.....

.....

.....

.....

.....

.....

11.0 MATHEMATICS

THE KENYA NATIONAL EXAMINATIONS COUNCIL
Kenya Certificate of Primary Education

503

MATHEMATICS

Oct. 2019 – 2 hours



INSTRUCTIONS TO CANDIDATES (Please read these instructions carefully)

1. You have been given this question booklet and a separate answer sheet. The question booklet contains 50 questions.
2. Do any necessary rough work in this booklet.
3. When you have chosen your answer, mark it on the **ANSWER SHEET**, not in this question booklet.

HOW TO USE THE ANSWER SHEET

4. Use an ordinary pencil.
5. Confirm that the answer sheet that you have been provided with has the following:
YOUR INDEX NUMBER
YOUR NAME
NAME OF YOUR SCHOOL
6. Do not make any marks outside the boxes.
7. Keep the sheet as clean as possible and do not fold it.
8. For each of the questions 1–50, four answers are given. The answers are lettered A, B, C and D. In each case only **ONE** of the four answers is correct. Choose the correct answer.
9. On the answer sheet, the correct answer is to be shown by drawing a **dark line** inside the box in which the letter you have chosen is written.

Example:

In the Question Booklet.

11. What is the value of $\frac{6(24-18)+6 \times 4}{6}$?
- A. 30
 - B. 25
 - C. 10
 - D. 28

The correct answer is C (10)

On the answer sheet:

11 [A] [B] [C] [D]

In the set of boxes numbered 11, the box with the letter C printed in it is marked.

10. Your **dark line MUST** be within the box.
11. For each question **ONLY ONE** box is to be marked in each set of four boxes.

This Question Paper consists of 16 printed pages.



909503

© 2019 The Kenya National Examinations Council

503



Turn over

1. What is two million six thousand four hundred and nine in numerals?
 - A. 2006409
 - B. 2600409
 - C. 2060409
 - D. 2006049

2. Which one of the following statements is correct?
 - A. $\frac{1}{2} < 0.5$
 - B. $\frac{3}{5} > \frac{5}{8}$
 - C. $0.63 < 0.36$
 - D. $\frac{1}{5} > \frac{1}{10}$

3. What is the difference between the total values of the digits in the thousands and hundreds position in the number 789240?
 - A. 200
 - B. 8800
 - C. 9000
 - D. 9200

4. What is the value of $(49365 - 9000 \div 3 + 1035) - 1250 \times 4$?
 - A. 52400
 - B. 42400
 - C. 40330
 - D. 52960

5. A farmer had 280 chicken. He sold $\frac{5}{7}$ of the chicken on the first day and then sold $\frac{1}{5}$ of the remainder the following day. How many chicken were sold?
 - A. 200
 - B. 64
 - C. 216
 - D. 16

6. Which is the next number in the pattern?
1, 3, 9, 27, 81, ____
 - A. 135
 - B. 108
 - C. 162
 - D. 243

7. A trader bought 21798 bags of maize in the first week. In the second week he bought 2476 bags less than what he had bought in the first week. In the third week he bought 542 bags more than he bought in the first week. How many bags of maize did he buy altogether?
- A. 68412
B. 63460
C. 62376
D. 24816
8. What is the value of $80.4 - \frac{(15.46 + 4.54)}{0.4}$?
- A. 30.4
B. 130.4
C. 151
D. 37.21
9. In a farm, on average every 6 cows produce 108 litres of milk per week. In five weeks the cows produced 2160 litres of milk. How many cows are in the farm?
- A. 432
B. 120
C. 24
D. 18
10. What is 759.968 rounded off to the nearest hundredth?
- A. 759.96
B. 759.9
C. 759.97
D. 760.0
11. In a race, Korir takes 12 seconds to run round a field. Muteti takes 18 seconds while Mwenda takes 27 seconds to run round the same field. If the three athletes start together, after how many seconds will they be together again?
- A. 3
B. 57
C. 5832
D. 108
12. What is the square root of 17.64?
- A. 42
B. 35.28
C. 8.82
D. 4.2

Working Space

13. The area of a rectangular piece of land is 220 square metres. Its width is 12.5 m. What is the perimeter of the piece of land?
- A. 17.6 m
B. 30.1 m
C. 60.2 m
D. 70.4 m
14. A rectangle brick weighs 3 kg 750 g. How many such bricks can be loaded into a lorry which can carry 3 tonnes?
- A. 8
B. 80
C. 800
D. 8000
15. Rono cycled from town R at an average speed of 72 km/h and took 3 hours 30 minutes to reach town S. Kepha cycled the same distance and took 4 hours. At what average speed was Kepha cycling?
- A. 18 km/h
B. $33\frac{3}{5}$ km/h
C. 63 km/h
D. 252 km/h
16. The figure below represents a piece of land.

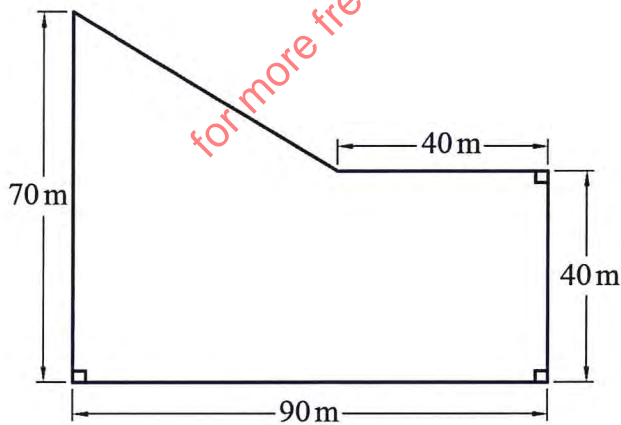

What is the area of the piece of land?

- A. 6300m^2
B. 4350m^2
C. 3600m^2
D. 6550m^2

Working Space

17. Muga left town P on Wednesday at 8.30 pm. He took 7 hours 50 minutes to reach town Q. On what day and time in 24 hours clock system did he reach town Q?
- A. Thursday 0420 h
B. Wednesday 0420 h
C. Wednesday 1620 h
D. Thursday 1620 h
18. An open rectangular tank has a base measuring 2.0 m by 1.5 m. It has a height of 2.5 m. The surface of the tank was painted. What was the total area painted?
- A. 7.5 m^2
B. 11.75 m^2
C. 20.5 m^2
D. 23.5 m^2
19. A cylindrical container of diameter 8 cm has a height of 35 cm. What is the volume of the container in cubic centimetres?
- (Take $\pi = \frac{22}{7}$)
- A. 1760
B. 7040
C. 880
D. 440

for more free papers visit: www.freekcpepapers.com

20. The figure below represents a flower garden in the shape of a triangle and a semi-circle.

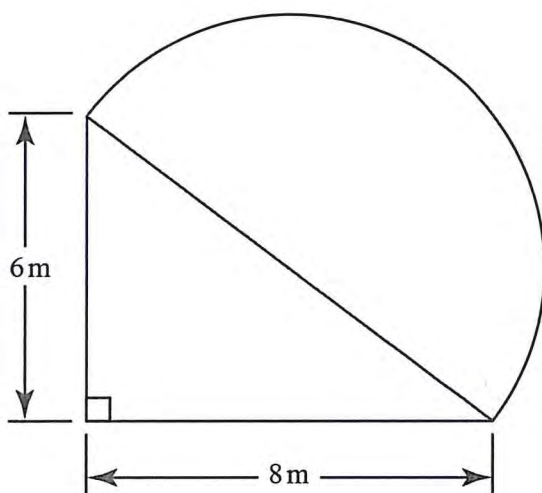

What is the area of the garden?

(Take $\pi = \frac{22}{7}$)

- A. $102\frac{4}{7}$ m²
 B. $29\frac{5}{7}$ m²
 C. $63\frac{2}{7}$ m²
 D. $39\frac{2}{7}$ m²
21. A cylindrical tank whose diameter is 140 cm has a height of 75 cm. How many litres of water can it hold when full?
 (Take $\pi = \frac{22}{7}$)
- A. 1155000
 B. 115500
 C. 11550
 D. 1155
22. What is the value of $x + \frac{2n-r}{y}$ where $x = 5$, $y = 2x$, $n = x + 9$ and $r = n + 6$?
- A. $2\frac{1}{2}$
 B. 2
 C. $6\frac{1}{5}$
 D. $5\frac{4}{5}$

23. Which one of the following expressions is the simplified form of $\frac{2(3x+y)+4x}{4(x+2y)-y}$
- A. $\frac{7x+2y}{x+y}$
- B. $\frac{10x+y}{4x+y}$
- C. $\frac{7x+y}{2x+3y}$
- D. $\frac{10x+2y}{4x+7y}$
24. Musa bought x bananas and Maria bought 4 bananas more than Musa. Otieno bought twice as many bananas as both Musa and Maria. The total number of bananas bought altogether was 30. Which one of the following equations can be used to find the number of bananas Musa bought?
- A. $6x + 12 = 30$
- B. $4x + 8 = 30$
- C. $2x + 6 = 30$
- D. $3x + 6 = 30$
25. What is the value of x in equation $\frac{3}{5}(2x+2) - 1 = 5$?
- A. 2
- B. $2\frac{1}{3}$
- C. 4
- D. $3\frac{2}{3}$

for more free papers visit: www.freekcpepapers.com

26. In the figure below construct a perpendicular bisector of line PR. Let the line intersect PR at T and meet line QS at H?

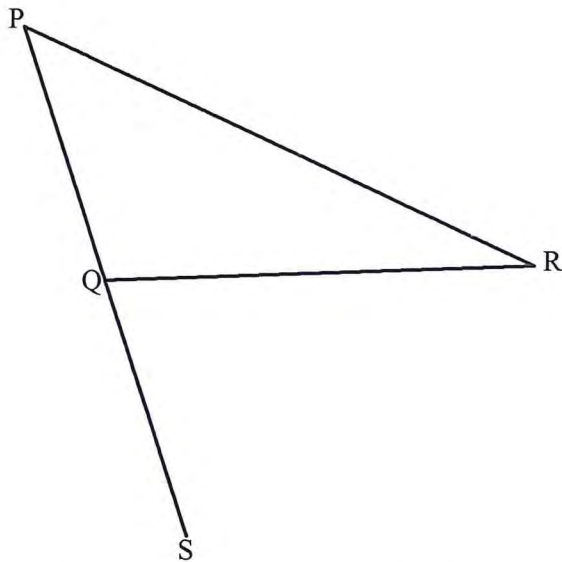

What is the measure of line HT in cm?

- A. 2.0 cm
 - B. 2.8 cm
 - C. 5.0 cm
 - D. 4.5 cm
27. In the figure below line QP is parallel to line RS, line QS = line SR and angle QSP = 32° .

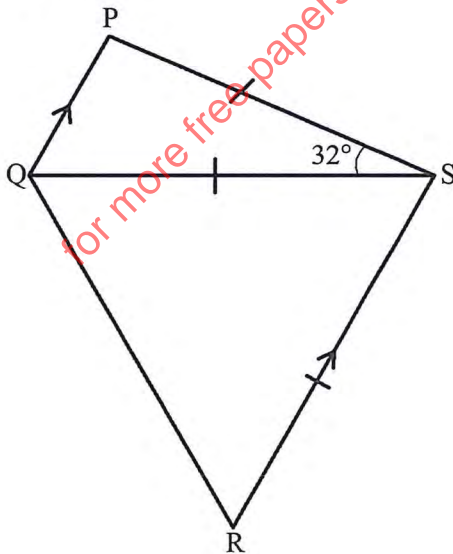

What is the size of angle PQR?

- A. 53°
- B. 74°
- C. 106°
- D. 127°

28. The figure below is part of a parallelogram EFGH. Complete the parallelogram.

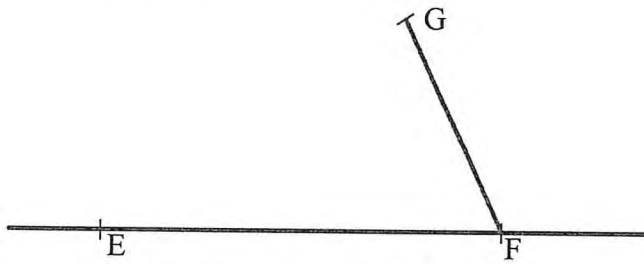

- What is the length of half of the longer diagonal?
- A. 3.7 cm
 B. 5.6 cm
 C. 6.0 cm
 D. 8.2 cm
29. In a certain school, the number of girls was 240 and the total number of pupils was 540. What was the ratio of boys to girls in the school?
- A. 9:4
 B. 5:9
 C. 4:5
 D. 5:4
30. What is the value of $1\frac{1}{2} + (2\frac{1}{4} \times 3\frac{1}{2} \text{ of } 12\frac{3}{4})$?
- A. 210
 B. $72\frac{3}{8}$
 C. 126
 D. $127\frac{1}{2}$

31. Triangle RST below is an isosceles triangle. The length $RT = RS = 10$ cm and $ST = 12$ cm.

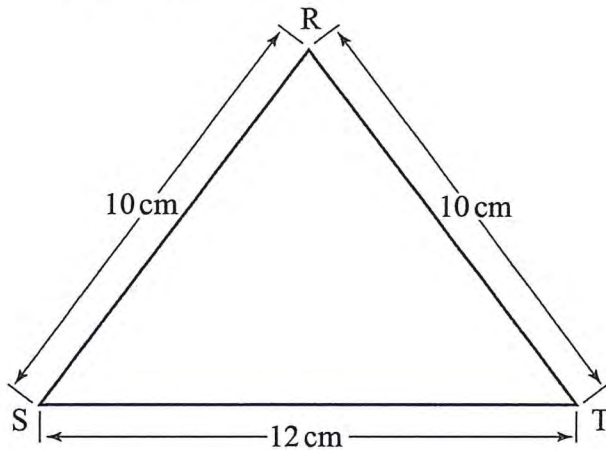

What is the area of the triangle?

- A. 32 cm^2
 - B. 48 cm^2
 - C. 24 cm^2
 - D. 60 cm^2
32. The diagram below is a net of a solid.

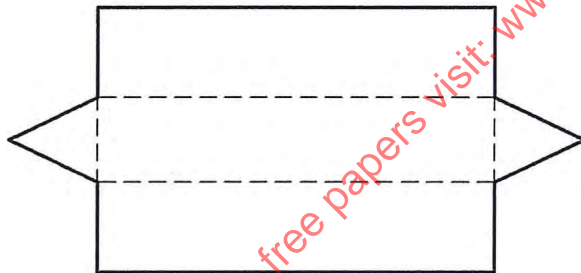

Which one of the following statements is true about the number of faces, edges and vertices for the solid?

- A. 5 faces, 10 edges and 10 vertices
 - B. 5 faces, 14 edges and 10 vertices
 - C. 5 faces, 9 edges and 6 vertices
 - D. 3 faces, 9 edges and 6 vertices
33. Which one of the following statements is true for both a trapezium and a rhombus?
- A. Opposite sides are equal
 - B. Have only one pair of parallel sides
 - C. The sum of the interior angles is 360°
 - D. Diagonals bisect at right angles

34. The figure below has been drawn accurately.

Working Space

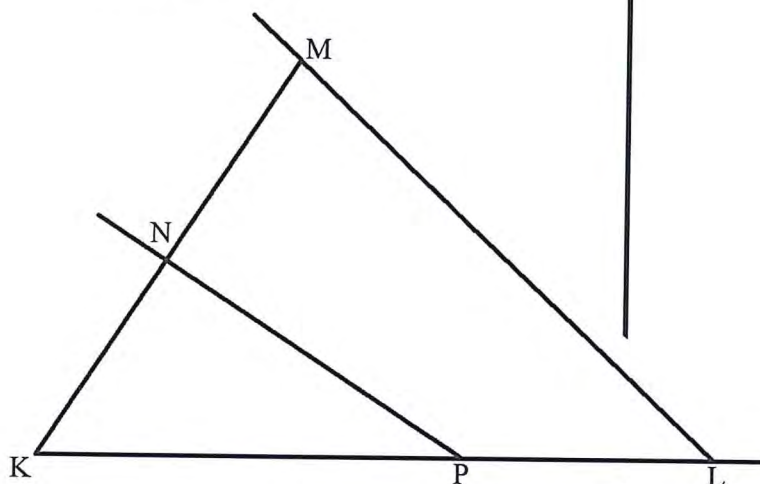

What is the size of the obtuse angle NPL?

- A. 33°
B. 180°
C. 213°
D. 147°
35. Amina bought 4 metres of material at sh250 per metre, 6 buttons at sh 8 each, a sewing thread for sh30 and made a dress. A similar dress costs sh 1500 in a shop. How much money did she save by making the dress?
- A. sh 1078
B. sh 1172
C. sh 462
D. sh 422
36. A fruit vendor bought 300 pineapples at sh210 for every 5 pineapples. She sold the pineapples at sh 60 each. How much profit did she make?
- A. sh 30 600
B. sh 5 400
C. sh 1 800
D. sh 12 600
37. Kazungu paid sh 3 200 for an item after getting a discount of 20%. What was the marked price for the item.
- A. sh 800
B. sh 2 560
C. sh 3 840
D. sh 4 000

38. A salesman earns a basic salary of sh40 000. He is also paid a commission of 3% of the value of goods he sells above sh100 000. In one month he sold sh20 000 items at sh 20 each. What was his total earnings that month?
- A. sh9 000
 B. sh43 000
 C. sh49 000
 D. sh52 000

39.

Mass	INLAND MAIL	INTERNATIONAL AIR MAIL		
		EAST AFRICA	REST OF AFRICA	EUROPE
	sh cts	sh cts	sh cts	sh cts
Not over 20g	35.00	45.00	55.00	60.00
Over 20g up to 50g	40.00	90.00	100.00	160.00
over 50g up to 100g	45.00	170.00	200.00	310.00
over 100g up to 250g	50.00	410.00	475.00	780.00

Weru posted the following letters:

1 letter weighing 101g to Kisumu in Kenya

1 letter weighing 19g to Uganda

2 letters weighing 80g each to Europe

1 letter weighing 50 g to Zambia

How much money did he pay for postage?

- A. sh975
 B. sh815
 C. sh915
 D. sh505
40. The hire purchase price of a sewing machine is made up of a deposit of sh4 000 and 18 equal monthly instalments of sh 1 200 each. Wanja was allowed a 20% discount on the hire purchase price for buying the sewing machine on cash.
- How much money did she pay?
- A. sh5 120
 B. sh20 480
 C. sh21 600
 D. sh25 600

41. Wanyama deposited sh 84 000 in a bank which paid simple interest at the rate of 10% per annum. How much money altogether, did he get if he withdrew all the money with the interest earned at the end of 7 months?
- A. sh 142 800
B. sh 4 900
C. sh 88 900
D. sh 92 400
42. Which one of the following represents the ratio 2:5 expressed as a percentage?
- A. $28\frac{4}{7}\%$
B. 40%
C. $71\frac{3}{7}\%$
D. 250%
43. Six people working for 5 days were paid a total of sh 6 000. How much more money would the same number of people be paid for 12 days?
- A. sh 8400
B. sh 14 400
C. sh 20 400
D. sh 1 200
44. A group of farmers harvested 10 000 kg of coffee on the first day and 8 000 kg on the second day. What was the percentage decrease in the amount of coffee harvested?
- A. 20%
B. 24%
C. 80%
D. 125%

45. The table below shows sales of shoes in 5 days. The sales for Wednesday are not shown.

Days of week	Monday	Tuesday	Wednesday	Thursday	Friday
Number of pairs of shoes sold	30	36	–	45	42

The total number of pairs of shoes sold was 180. If a pie chart was to be drawn to represent this information, what angle would represent the number of pairs sold on Wednesday

- A. 153°
 B. 27°
 C. 306°
 D. 54°
46. The graph below represents a journey of a cyclist travelling from town W to town P through towns L, K and M?

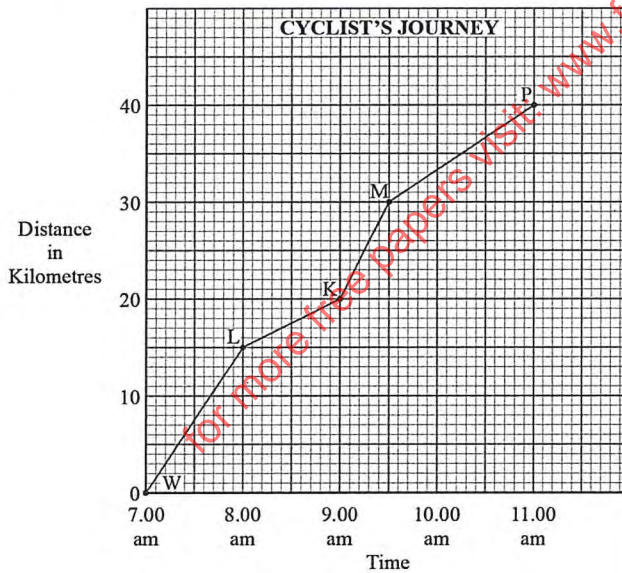

Between which two towns was the cyclist travelling at the highest speed?

- A. KM
 B. LK
 C. WL
 D. MP

47. The table below shows train fares from town N to town M:

	1st Class	2nd Class
Adults and children above 11 years	sh 3000	sh 700
Children between 3 years and 11 years	sh 1800	sh 400
Children under 3 years	Free	Free

A certain school arranged for a trip by train from town N to town M. 28 pupils aged 12 years, 15 pupils aged between 7 years and 10 years, 4 teachers and the head teacher.

The passengers occupied the following classes in the train:

1st class: The head teacher and one teacher.

2nd class: 3 teachers and all the pupils.

How much money did they pay for the trip altogether?

- A. sh 33700
 B. sh 38200
 C. sh 27700
 D. sh 31400
48. The distance in kilometres between towns P, Q, R and S is shown below.

P			
100	Q		
170	140	R	
210	180	90	S

What is the distance from town S to town P via town R?

- A. 400 km
 B. 210 km
 C. 260 km
 D. 330 km
49. The scale of a building plan is 1:200. What length, in cm, on the plan represents 5 metres of the building?
- A. 0.4
 B. 2.5
 C. 0.025
 D. 40

50. The number of pupils present in a class in a certain week is shown in the table below:

Days of the week	Monday	Tuesday	Wednesday	Thursday	Friday
Number of pupils	45	36	43	45	41

What was the mean attendance for the class that week?

- A. 36
- B. 42
- C. 43
- D. 45

Working Space

for more free papers visit: www.freekcpepapers.com

THE KENYA NATIONAL EXAMINATIONS COUNCIL
Kenya Certificate of Primary Education

507

— SCIENCE —



Oct. 2019 – 1 hour 40 minutes



INSTRUCTIONS TO CANDIDATES (Please read these instructions carefully)

1. You have been given this question booklet and a separate answer sheet. The question booklet contains 50 questions.
2. Do any necessary rough work in this booklet.
3. When you have chosen your answer, mark it on the **ANSWER SHEET**, not in this question booklet.

HOW TO USE THE ANSWER SHEET

4. Use an ordinary pencil only.
5. Confirm that the answer sheet that you have been provided with has the following:
YOUR INDEX NUMBER
YOUR NAME
NAME OF YOUR SCHOOL
6. Do not make any marks outside the boxes.
7. Keep the sheet as clean as possible and do not fold it.
8. For each of the questions 1–50 four answers are given. The answers are lettered A, B, C and D. In each case only **ONE** of the four answers is correct. Choose the correct answer.
9. On the answer sheet, show the correct answer by drawing a **dark line** inside the box in which the letter you have chosen is written.

Example:

In the Question Booklet.

4. Which one of the following components of blood is involved in clotting after injury?
 - A. Plasma
 - B. White blood cells
 - C. Red blood cells
 - D. Platelets.

The correct answer is D.

On the answer sheet:

4 [A] [B] [C] [D]

In the set of boxes numbered 4, the box with the letter D printed in it is marked.

10. Your **dark line MUST** be within the box.
11. For each question **ONLY ONE** box is to be marked in each set of four boxes.

This Question Paper consists of 7 printed pages and 1 blank page.



909507

© 2019 The Kenya National Examinations Council

507



Turn over

50. The number of pupils present in a class in a certain week is shown in the table below:

Days of the week	Monday	Tuesday	Wednesday	Thursday	Friday
Number of pupils	45	36	43	45	41

What was the mean attendance for the class that week?

- A. 36
- B. 42
- C. 43
- D. 45

Working Space

for more free papers visit: www.freekcpepapers.com

THE KENYA NATIONAL EXAMINATIONS COUNCIL
Kenya Certificate of Primary Education

507

— SCIENCE —



Oct. 2019 – 1 hour 40 minutes



INSTRUCTIONS TO CANDIDATES (Please read these instructions carefully)

1. You have been given this question booklet and a separate answer sheet. The question booklet contains 50 questions.
2. Do any necessary rough work in this booklet.
3. When you have chosen your answer, mark it on the **ANSWER SHEET**, not in this question booklet.

HOW TO USE THE ANSWER SHEET

4. Use an ordinary pencil only.
5. Confirm that the answer sheet that you have been provided with has the following:
YOUR INDEX NUMBER
YOUR NAME
NAME OF YOUR SCHOOL
6. Do not make any marks outside the boxes.
7. Keep the sheet as clean as possible and do not fold it.
8. For each of the questions 1–50 four answers are given. The answers are lettered A, B, C and D. In each case only **ONE** of the four answers is correct. Choose the correct answer.
9. On the answer sheet, show the correct answer by drawing a **dark line** inside the box in which the letter you have chosen is written.

Example:

In the Question Booklet.

4. Which one of the following components of blood is involved in clotting after injury?
A. Plasma
B. White blood cells
C. Red blood cells
D. Platelets.

The correct answer is D.

On the answer sheet:

4 [A] [B] [C] [D]

In the set of boxes numbered 4, the box with the letter D printed in it is marked.

10. Your **dark line MUST** be within the box.
11. For each question **ONLY ONE** box is to be marked in each set of four boxes.

This Question Paper consists of 7 printed pages and 1 blank page.



909507

© 2019 The Kenya National Examinations Council

507



Turn over

1. Which one of the following pairs of human body parts is used in breathing?

- A. Lungs and oesophagus.
- B. Nose and trachea.
- C. Diaphragm and stomach.
- D. Nose and oesophagus.

2. Which one of the following waste products is excreted by the lungs?

- A. Excess salts.
- B. Urine.
- C. Sweat.
- D. Excess water.

3. Which one of the following pairs of diseases **only** consists of sexually transmitted infections?

- A. Gonorrhoea and malaria.
- B. HIV/AIDS and measles.
- C. Syphilis and chancroid.
- D. Bilharzia and Gonorrhoea.

4. Which one of the following is the **third** stage of HIV/AIDS infections?

- A. Symptomatic.
- B. Window.
- C. Full blown.
- D. Incubation.

5. Which one of the following components of the environment is the **main** source of energy for living things?

- A. Plants.
- B. Air.
- C. Water.
- D. Soil.

6. Which one of the following **least** pollutes the soil?

- A. Excess fertilisers.
- B. Oil spillage.
- C. Kitchen leftovers.
- D. Mining.

7. The soil that cracks easily when dry has

- A. a rough texture.
- B. small particles.
- C. large airspace.
- D. low capillarity.

8. The diagram below shows a set-up used to investigate a certain component of soil.

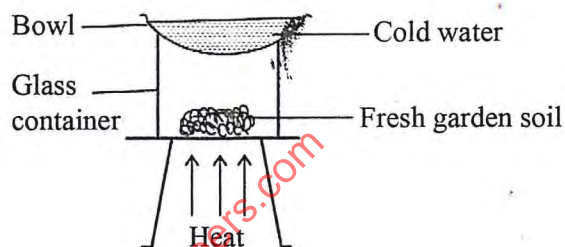

The component of soil that was investigated is

- A. living organisms.
- B. organic matter.
- C. air.
- D. water.

9. Which one of the following pairs of types of soil erosion forms V-shaped ditches?

- A. Gully and rill.
- B. Sheet and gully.
- C. Rill and splash.
- D. Splash and sheet.

10. Which one of the following nutritional deficiency diseases is **more** likely to be suffered by mothers of newly born babies?

- A. Kwashiorkor.
- B. Marasmus.
- C. Anaemia.
- D. Rickets.

11. Which one of the following foods is **more** rich in **both** proteins and fats?

- A. Avocado.
- B. Milk.
- C. Sunflower.
- D. Beans.

12. The following produce special sounds, **except** sound from a
- hooting car.
 - fire engine.
 - ringing bell.
 - moving tractor.
13. The diagram below shows a set-up that can be used to investigate heat transfer in a liquid. What should be added to the water for the pupils to observe heat transfer?

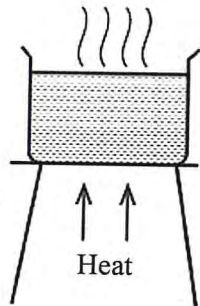

- Salt.
 - Stones.
 - Saw dust.
 - Wax.
14. In which of the following devices is renewable energy used?
- Battery.
 - Kerosene stove.
 - Burning candle.
 - Charcoal jiko.
15. The following activities were done when it was raining:
- walking bare footed on the road
 - lying on the bed
 - playing football in the field
 - driving a car on the road.

In which **two** activities is one **more** likely to be struck by lightning?

- (i) and (ii).
- (ii) and (iv).
- (i) and (iii).
- (i) and (iv).

16. Which one of the following sources of electricity pollutes air?
- Dynamo.
 - Geothermal generator.
 - Biogas driven generator.
 - Solar panel.

17. Which one of the following groups of materials consists **only** of materials that are magnetic?
- Bottle top, copper coin, aluminium foil.
 - Razor blade, staple pins, steel wool.
 - Spoon, copper wire, silver coin.
 - Nail, aluminium foil, silver coin.

18. The chart below represents a simple classification of liquids

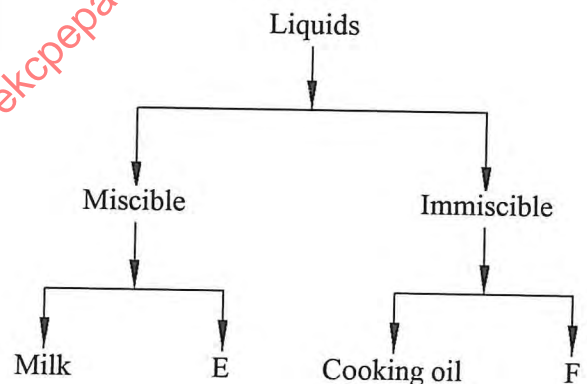

Which liquids are represented by E and F?

- | E | F |
|----------------|----------|
| A. Kerosene | Water |
| B. Water | Milk |
| C. Cooking oil | Milk |
| D. Water | Kerosene |
19. Which one of the following materials allows light to pass through but one **cannot** see through?

- Fluorescent tube.
- Smoke.
- Clean water.
- Mirror.

20. The percentage of the component of air that makes a bulb glow without burning is

- A. 78%
- B. 21%
- C. 0.03%
- D. 0.97%

21. Which one of the following groups of substances has definite volume and shape?

- A. Oxygen, water and ice.
- B. Ink, grease, glucose.
- C. Flour, powdered chalk, salt.
- D. Sand, powdered milk, methylated spirit.

22. Which one of the following machines works in the **same** way as a crowbar?

- A. Spade.
- B. Claw hammer.
- C. Ladder.
- D. Wheel barrow.

23. The following machines make work easier by reducing the effort required **except**

- A. crowbar.
- B. ramp.
- C. flag post.
- D. ladder.

24. Which one of the following statements is **true** about rain water?

- A. Uses more soap during washing.
- B. Saves time and energy during washing.
- C. Is rich in minerals.
- D. Stains clothes.

25. A pupil who buys mango fruits from market and eats without washing is likely to be infected with

- A. typhoid and cholera
- B. bilharzia and cholera
- C. typhoid and malaria
- D. bilharzia and malaria.

26. Which of the following practices conserves water by using it sparingly?

- A. Treating and using sewage water.
- B. Harvesting rain water.
- C. Using water used to wash vegetables to water plants.
- D. Supplying water once a week.

27. Which of the following groups of activities **only** consists of industrial uses of water?

- A. Fishing, transport, mixing chemicals.
- B. Washing vehicles, constructing roads, mixing chemicals.
- C. Boat racing, swimming, fishing.
- D. Cooling machines, drinking, cleaning of tools.

28. Which one of the following pairs of blood vessels carries deoxygenated blood?

- A. Venacava and aorta.
- B. Pulmonary artery and pulmonary vein.
- C. Venacava and pulmonary artery.
- D. Pulmonary vein and aorta.

29. Which one of the following features is **least** important when describing a molar tooth?

- A. Roots.
- B. Cusps.
- C. Broadness.
- D. Hardness.

30. Which one of the following components of blood is **correctly** matched to its function?

Blood component	Function
A. Plasma	Transports oxygen.
B. White blood cells	Heat distribution.
C. Platelets	Blood clotting.
D. Red blood cell	Transports iron.

31. The following are some effects of drug abuse:

- (i) drug induced accidents
- (ii) addiction
- (iii) coma
- (iv) rape
- (v) truancy
- (vi) impaired judgement.

Which **three** are classified as health effects?

- A. (i), (ii), (v).
- B. (iii), (iv), (v).
- C. (ii), (iii), (vi).
- D. (i), (iii), (iv).

32. The following are some characteristics of a certain vertebrate:

- (i) scales on the body
- (ii) varying body temperatures
- (iii) lay externally fertilised eggs

The animal with the above characteristics is likely to be

- A. salamander.
- B. shark.
- C. lizard.
- D. duck.

33. Which one of the following is the **main** effect of HIV/AIDS on the nation?

- A. Increased medical expenses.
- B. Poor health.
- C. Stigmatisation.
- D. Lack of parental care.

34. Which of the following statements is **true** about the immunisation schedule of infants?

- A. DPT vaccine is given at birth and the 6th week.
- B. BCG and polio vaccines are given at birth and the 6th week.
- C. DPT and measles vaccine are given at the 10th week.
- D. Polio and DPT vaccines are given at the 6th week.

35. The **best** way of preventing the spread of HIV/AIDS among the youths in Kenya is

- A. seeking medication.
- B. being faithful to their partners.
- C. abstinence.
- D. testing and counselling.

36. Which one of the following plants is classified as **both** green and non flowering?

- A. Mosses.
- B. Sugarcane.
- C. Grass.
- D. Mushroom.

37. A pupil classified drugs as shown below.

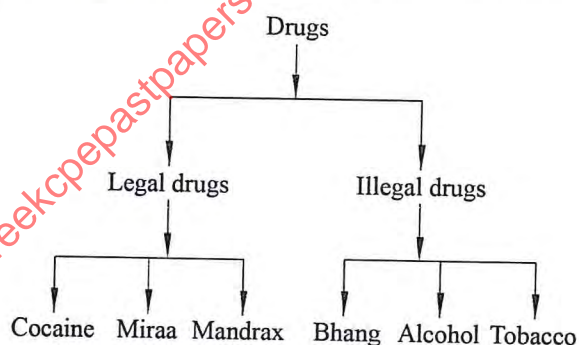

Which drugs were **correctly** classified by the pupil?

- A. Miraa and bhang.
- B. Tobacco and mandrax.
- C. Cocaine and miraa.
- D. Bhang and alcohol.

38. Which one of the following pairs of crop pests is likely to attack a crop of maize growing in the field?

- A. Weevils and aphids.
- B. Cutworms and rodents.
- C. Weaver birds and rodents.
- D. Weaver birds and cutworms.

39. A plant with deep and widespread root system is also likely to have
- many stomata.
 - flexible stems.
 - thick cuticles.
 - thin cuticles.
40. Which one of the following weeds **cannot** be effectively controlled by uprooting?
- Mexican marigold.
 - Oxalis.
 - Wondering jew.
 - Black jack.
41. The following are characteristics of a certain type of cloud **except**
- appears high in the sky.
 - indicates fine weather.
 - is dark grey in colour.
 - has a flat base.
42. The diagram below shows a cross section of a maize grain.

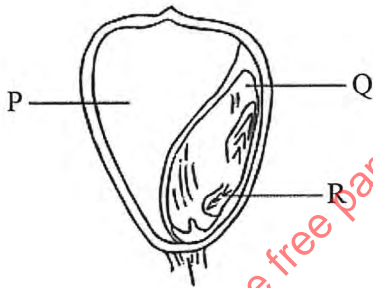

Which one of the following **correctly** identifies the parts labelled P, Q and R.

- | P | Q | R |
|--------------|-----------|----------|
| A. Endosperm | cotyledon | radicle. |
| B. Endosperm | cotyledon | plumule. |
| C. Cotyledon | endosperm | plumule. |
| D. Cotyledon | endosperm | radicle. |

43. Which one of the following groups only consists of planets in the **3rd, 5th and 8th** position in the solar system?
- Venus, Jupiter, Uranus.
 - Earth, Jupiter, Neptune.
 - Mercury, Mars, Saturn.
 - Venus, Uranus, Jupiter.
44. Which one of the following is an adaptation for **both** flying and swimming?
- Strong hind legs.
 - Presence of wings.
 - Webbed feet.
 - Streamlined body.
45. The following are adaptations for feeding in herbivores. Which **two** are for turning food in the mouth?
- Presence of horny pad and continuously growing teeth.
 - Rough tongue and presence of diastema.
 - Presence of horny pad and rough tongue.
 - Continuously growing teeth and presence of diastema.
46. Which one of the following characteristics differentiates amphibians from reptiles?
- Cold blooded.
 - Body covered with scales.
 - Partly live in water.
 - Lay eggs.
47. Which one of the following does **not** conserve energy?
- Using a bicycle dynamo for lighting.
 - Using an improved jiko for cooling.
 - Using biogas for cooking.
 - Planting trees.

48. The diagram below shows a set-up prepared by a pupil to investigate an aspect of sound.

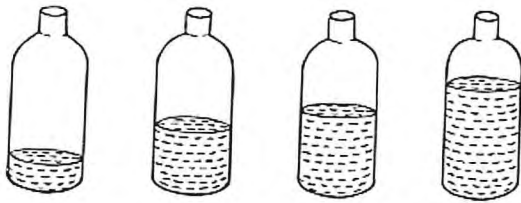

The aspect of sound investigated by the pupil is

- A. production of sound by hitting.
 - B. sources of sound.
 - C. loud and soft sounds.
 - D. special sounds.
49. The diagram below shows a person riding a bicycle.



Which one of the following does **not** reduce friction during riding?

- A. Leaning forward on the ride.
- B. Treaded tyres.
- C. Ball bearings in the wheels.
- D. The shape of the wheels.

50. The diagram below shows some parasites labelled S, T, V and W.

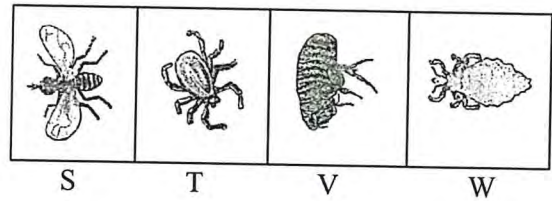

Which one of the parasites is **more** likely to reduce the quality of wool in sheep?

- A. S
- B. T
- C. V
- D. W

13.0 SOCIAL STUDIES AND RELIGIOUS EDUCATION

THE KENYA NATIONAL EXAMINATIONS COUNCIL
Kenya Certificate of Primary Education

506 — **SOCIAL STUDIES AND
RELIGIOUS EDUCATION** —
Oct. 2019 – 2 hours 15 minutes



INSTRUCTIONS TO CANDIDATES (Please read these instructions carefully)

1. You have been given this question booklet and a separate answer sheet. The question booklet contains 90 questions.
2. Do any necessary rough work in this booklet.
3. When you have chosen your answer, mark it on the **ANSWER SHEET**, not in this question booklet.

HOW TO USE THE ANSWER SHEET

4. Use an ordinary pencil.
5. Confirm that the answer sheet that you have been provided with has the following:
YOUR INDEX NUMBER
YOUR NAME
NAME OF YOUR SCHOOL
6. Do not make any marks outside the boxes.
7. Keep the sheet as clean as possible and do not fold it.
8. For each of the questions 1–90, four answers are given. The answers are lettered A, B, C and D. In each case, only **ONE** of the four answers is correct. Choose the correct answer.
9. On the answer sheet, the correct answer is to be shown by drawing a **dark line** inside the box in which the letter you have chosen is written.

Example:

In the Question Booklet.

33. Among the Agikuyu, people who were initiated together formed
- A. a sub-tribe
 - B. a clan
 - C. a generation
 - D. an age-group

The correct answer is "D"

On the answer sheet:

33 [A] [B] [C]

In the set of boxes numbered 33, the box with the letter D printed in it is marked.

10. Your **dark line MUST** be within the box.
11. For each question **ONLY ONE** box is to be marked in each set of four boxes.

This Question Paper consists of 16 printed pages.



909506

© 2019 The Kenya National Examinations Council

506



Turn over





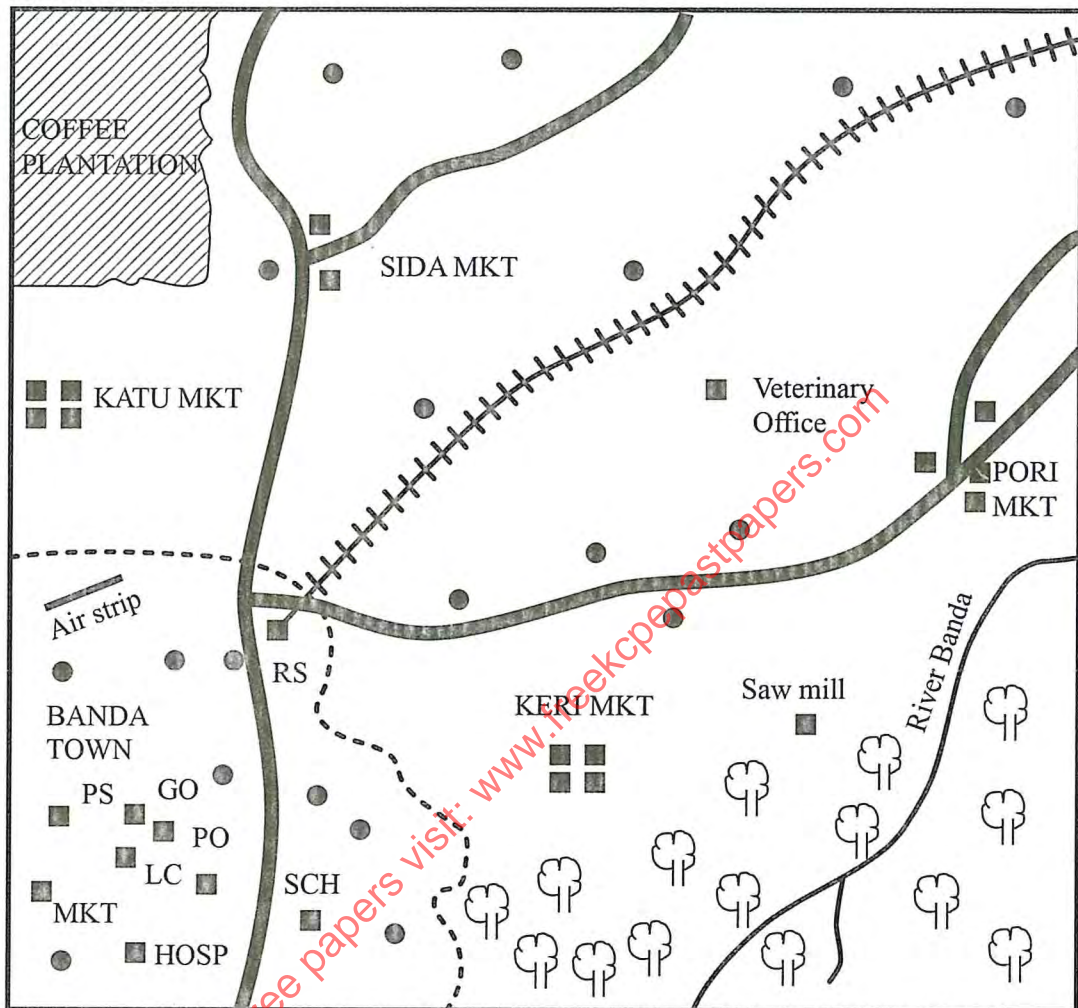

PART I: SOCIAL STUDIES

BANDA AREA



Scale 0 1 2 3 4 5 6 7 8 9 10 Kilometres

KEY

- | | | | |
|---|---------------------|------|-------------------|
|  | Tarmac road | GO | Governor's office |
|  | River | HOSP | Hospital |
|  | Town boundary | MKT | Market |
|  | Permanent buildings | PO | Post office |
|  | Houses | PS | Police station |
|  | Forest | LC | Law courts |
|  | Railway line | RS | Railway station |
| | | SCH | School |

Study the map of Banda Area and answer questions 1–7.

1. What is the direction of the veterinary office from the market at Banda town?
 - A. North.
 - B. North East.
 - C. South.
 - D. South East.
2. The approximate area of the coffee plantation in square kilometres is
 - A. 6 km²
 - B. 7 km²
 - C. 12 km²
 - D. 16 km².
3. The climate of the area around Keri market is likely to be
 - A. warm and dry
 - B. cool and wet
 - C. hot and wet
 - D. cool and dry.
4. The **main** means of transport in Banda area is
 - A. road
 - B. air
 - C. railway
 - D. water.
5. Which one of the following statements is **true** about settlement in Banda area?
 - A. Most settlements are found near the river.
 - B. The settlements are scattered.
 - C. Most settlements are in Banda town.
 - D. The settlements are found along the railway line.
6. The following economic activities are carried out in Banda area **except**
 - A. lumbering
 - B. cattle keeping
 - C. mining
 - D. crop farming.
7. What evidence on the map shows that Banda town is an administrative centre?
 - A. Governor's Office.
 - B. Law Courts.
 - C. Police Station.
 - D. Post Office.
8. The original homeland of the Nilotes was
 - A. Bahr el Ghazal
 - B. Taita hills
 - C. Horn of Africa
 - D. Congo basin.
9. How long does the earth take to complete a rotation on its axis?
 - A. Twelve hours.
 - B. Twenty four hours.
 - C. Fifteen hours.
 - D. One hour.
10. In traditional African societies, stories were told to the children so that they could
 - A. memorise the stories
 - B. learn the moral teachings
 - C. praise the story tellers
 - D. read story books.
11. The reason why John Speke came to Eastern Africa was to
 - A. explore the source of river Nile
 - B. abolish slave trade
 - C. spread Christianity
 - D. set up administrative centres.
12. Three of the following are factors that influence the climate of Africa **except**
 - A. direction of winds
 - B. shape of the land
 - C. distance from the Prime Meridian
 - D. height above sea level.
13. Which one of the following groups of communities belong to the Coastal Bantus?
 - A. Taita, Pokomo, Mijikenda.
 - B. Abakuria, Abagusii, Abaluhya.
 - C. Akamba, Aembu, Ameru.
 - D. Pokomo, Agikuyu, Abakuria.

14. Three of the following are responsibilities of spouses in a family. Which one is **not**?

- A. Ensuring children are in gainful employment.
- B. Protecting all members of the family.
- C. Ensuring proper upbringing of children.
- D. Providing for the basic needs of the family.

15. Which one of the following groups of crops in Kenya were grown under subsistence farming?

A	B
Maize Cabbages Carrots	Cassava Sweet Potatoes Millet
C	D
Beans Avocado Rice	Oranges Water melon Wheat

16. While crossing the road in Kenya, a pedestrian should do three of the following **except**

- A. Check traffic lights
- B. Check right and left sides
- C. Use zebra crossing zones
- D. Run across the road.

17. Which one of the following is an effect of urban to rural migration?

- A. Increased agricultural production.
- B. Increased residential houses.
- C. Increased market for agricultural goods.
- D. Shortage of labour in the farms.

18. Which one of the following diagrams represents a traditional form of communication?

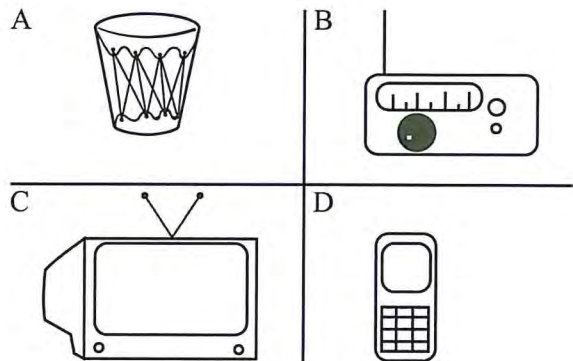

19. Which one of the following statements describes a school motto?

- A. A programme followed in a school.
- B. A guide that helps teachers and pupils plan their work.
- C. A guide to teachers and pupils activities.
- D. A statement that describes the goals pupils ought to achieve.

20. Who among the following leaders resisted the British during the establishment of colonial rule in Kenya?

- A. Nabongo Mumia.
- B. Waiyaki wa Hinga.
- C. Koitalel Arap Samoei.
- D. Karuri wa Gakure.

21. The Ruwenzori mountains were formed as a result of

- A. faulting
- B. folding
- C. erosion
- D. volcanicity.

22. Which one of the following instruments is **correctly** matched with the weather element it measures?

- A. Thermometer – wind speed.
- B. Anemometer – Atmospheric pressure.
- C. Barometer – Temperature.
- D. Hygrometer – Humidity.

23. Which one of the following is the **best** way to promote peace in a family?
- Encouraging children to go to school.
 - Children respecting each other.
 - Discussing matters with each other.
 - Encourage sharing of work at home.
24. Which one of the following statements is **true** about population distribution in Kenya?
- Majority of the people live in towns.
 - Most of the population is found in the highlands.
 - The lake region has sparse population.
 - Most people live along the valleys.

Use the map of Eastern Africa provided below to answer questions 25 to 28



25. The language group that migrated into Kenya using the route marked **P** is
- Bantus
 - Cushites
 - Nilotes
 - Semites.
26. The country marked **Q** is
- Somali
 - Djibouti
 - Ethiopia
 - Eritrea.

27. The cash crop grown in the shaded area marked **R** is
- Coffee
 - Tea
 - Bananas
 - Sugarcane.
28. The lake marked **S** was formed as a result of
- faulting
 - human activities
 - deposition of lava
 - wind erosion.
29. Which one of the following is the **main** fresh water fish in Kenya?
- Nile perch.
 - Mud fish.
 - Trout.
 - Tilapia.
30. Which one of the following plants consist of desert vegetation?
- Open grassland.
 - Short thorny trees.
 - Tall evergreen trees.
 - Tall elephant grass.
31. Below are some conditions that favour the growing of a crop.
- High temperatures.
 - High humidity.
 - Moderate rainfall.
 - Well drained fertile soils.
- The conditions described above favour the growing of
- Cloves
 - Pyrethrum
 - Tea
 - Cotton.
32. Which one of the following activities **mainly** threatens the existence of natural forests in Kenya?
- Collecting herbs for making medicine.
 - Clearing the forests for settlements.
 - Destruction of trees by wild animals.
 - Felling of trees for electricity poles.

33. The government of Kenya encourages ranching among pastoralists **mainly** to

- A. provide veterinary services
- B. ensure efficient use of resources
- C. increase beef production
- D. improve their standards of living.

34. In traditional African societies an age-group was made up of people who

- A. belonged to the same clan
- B. married at the same time
- C. played together
- D. came from the same village.

35. The following are some characteristics of a type of vegetation

- (i) Trees have needle-like waxy leaves
- (ii) Trees have long tap roots
- (iii) Some trees are cone shaped
- (iv) Trees have thick stems

The type of vegetation described above is

- A. tropical rain forest
- B. savanna
- C. Mediterranean.
- D. mountain.

36. The colonial system of administration applied in Mozambique was

- A. Direct rule
- B. Paternalism
- C. Indirect rule
- D. Assimilation.

37. The following statements describe characteristics of a relief region in Kenya.

- (i) Low lying with an attitude of 0-250 metres.
- (ii) Gently sloping land.
- (iii) Few raised features.

The region described above is

- A. The Nyika Plateau
- B. The Rift Valley
- C. Lake Basin
- D. Coastal lowlands.

38. Below are statements about a town in Kenya.

- (i) It is an industrial centre.
- (ii) It is an educational centre.
- (iii) It is a tourist town.
- (iv) It is an agricultural centre.

The town described above is

- A. Eldoret
- B. Kisumu
- C. Nairobi
- D. Thika.

39. Juma a class eight pupil on his way to school witnessed his classmate being hit by a motor cycle. The right action that Juma would take is

- A. Give first aid
- B. Keep quiet about the matter
- C. Caution the motor cycle rider
- D. Call people to beat the motor cycle rider.

40. Jua kali industries are encouraged in Kenya in order to

- A. attract foreign investors
- B. use locally available materials
- C. make use of high skilled labour
- D. provide raw materials for other industries.

41. Peter has found out that his son John has been smoking cigarettes. What would be the right thing to do?

- A. Take John to the police.
- B. Report John to the head teacher.
- C. Take John for guidance and counselling.
- D. Give John a punishment.

42. Which one of the following is an economic right?

- A. Right to education.
- B. Right to decent housing.
- C. Right to health care.
- D. Right to marry.

43. Three of the following are a threat to tourism industry. Which one is **not**?
- Poaching.
 - Increase in road accidents.
 - Environmental pollution.
 - Political instability.
44. Mary, a class six pupil, was asked by her teacher to name one item that is exported by Kenya. Her correct answer would be
- electronics
 - chemicals
 - tea
 - motor vehicles.
45. One of the objectives of the Organisation of African Union (OAU) was to
- eradicate all forms of colonialism
 - execute plans to eradicate HIV/AIDs
 - form peace keeping force
 - mediate in peace process between member states.
46. Which one of the following posts was created by the National accord following the post election violence of 2007?
- Governor.
 - Senator.
 - Principal Secretary.
 - Prime Minister.
47. Which one of the following methods is used to extract fluorspar in Kerio Valley?
- Shaft.
 - Open cast.
 - Panning.
 - Drilling.
48. The Berlin Conference was held by European powers in order to
- divide Africa among the European powers
 - establish a market for their manufactured goods
 - protect their companies in the region
 - encourage their explorers to come to Africa.
49. The benefit of horticultural farming in Kenya is mainly to
- provide employment opportunities
 - earn the country foreign exchange
 - promote development of towns
 - ensure self sufficiency in food.
50. In Kenya, the post of a Senator is filled through
- election by members of parliament
 - appointment by the President
 - election by voters in the country
 - appointment by the civil service.
51. The following are agencies of United Nations **except**
- World Health Organisation
 - The World Bank
 - The Commonwealth
 - Food and Agricultural Organisation.
52. Two communities are fighting over grazing land. The **best** way to resolve the conflict is by
- imposing heavy fines on the communities
 - mediating between communities
 - ensuring that they are not armed
 - sending more police officers in the affected areas.
53. Three of the following are elements of citizenship. Which one is **not**?
- Owning property in the country.
 - Obeying the laws of the country.
 - Participating in electoral process.
 - Being loyal to the country.
54. One of the factors that **undermine** national unity in the society is
- participating in trade
 - participating in sporting activities
 - intermarriages between communities
 - poor distribution of resources.

55. One of the reasons why Samori Toure was defeated in the Mandinka War was that
- the Muslim subjects rebelled against him
 - the French were supported by the British
 - he was influenced by the missionaries to surrender
 - the French interfered with his trading activities at the Coast.
56. The following are effects of lawlessness in a school. Which one is **not**?
- Destruction of school property.
 - Frequent fights among pupils.
 - Lagging behind in development.
 - Improper sharing of school books.
57. Which one of the following groups of countries belong to South African Development Community?
- Angola, Mauritius, Tanzania.
 - South Africa, Uganda, Zimbabwe.
 - Mali, Liberia, Democratic Republic of Congo (DRC).
 - Zambia, Somalia, Madagascar.
58. One of the benefits of democracy is that
- the elected leaders are above the law
 - there is respect of human rights
 - people with similar political opinion live together
 - people are made to join the ruling party.
59. Which one of the following is a function of the National government?
- Providing security.
 - Making by-laws.
 - Providing water.
 - Collecting garbage.
60. One of the subordinate courts in Kenya is
- Supreme Court
 - Court of Appeal
 - High Court
 - Magistrate Court.

PART II: RELIGIOUS EDUCATION
SECTION A
CHRISTIAN RELIGIOUS STUDIES

61. According to the Biblical creation stories, human beings are special **mainly** because they were
- allowed to live in the garden of Eden
 - given authority over other creations
 - created in the image of God
 - given names by God.
62. Which one of the following is a promise that God made to Abraham?
- "I will give you an everlasting Kingdom."
 - "You will serve me as a Priest."
 - "Through you I will bless all the nations."
 - "I will keep your kingdom strong."
63. Who among the following people is the father of the Israelites?
- Isaac.
 - Jacob.
 - Esau.
 - Terah.
64. During the night of passover, the first born sons of the Israelites were
- spared by the angel of the Lord
 - purified by the elders
 - rewarded for their courage
 - dedicated to God.
65. Which one of the following was used by Moses to seal the covenant between God and the Israelites at Mount Sinai?
- Altar.
 - Blood of oxen.
 - Ten Commandments.
 - Rod.
66. When King Saul was tormented by an evil spirit, David helped him to calm down by
- telling him stories
 - reading for him scriptures
 - praying for him
 - playing the harp for him

67. Which one of the following is a reason why King Ahab of Israel had Naboth killed? Because Naboth had
- cursed God and the king
 - taken Uriah's wife
 - refused to sell his vineyard to him
 - disrespected the king.
68. "Now go to the town of Zarephath near Sidon and stay there. I have commanded a widow who lives there to feed you." (1 Kings 17:9). God said these words to Prophet
- Elijah
 - Samuel
 - Isaiah
 - Nathan.
69. The **main** lesson Christians learn from the incident in which Prophet Elisha healed Naaman of leprosy is that they should
- be humble to their church leaders
 - have hope in difficulty
 - obey instructions
 - co-operate with people.
70. Who among the following people presented gifts to baby Jesus?
- Anna the Prophetess.
 - Visitors from the East.
 - The shepherds.
 - Zechariah the priest.
71. When Jesus was presented in the temple for dedication by his parents, Simeon described Him as the
- lamb of God
 - King of the Jews
 - Saviour of all people
 - Prince of peace.
72. "Take nothing with you for the trip, no walking stick, no beggar's bag, no food, no money..." (Luke 9:3)
- A lesson Christians learn from this instruction that Jesus gave to his disciples when He sent them on a mission is that they should
- depend on God for provision
 - fast when preaching the word of God
 - not desire earthly materials
 - travel with little luggage.
73. Which one of the following miracles of Jesus shows that He has power to forgive sins?
- Roman officer's servant.
 - Paralysed man.
 - Blind man.
 - Ten lepers.
74. The **main** lesson Christians learn from the parable of the lost son is that they should
- confess their sins
 - share their wealth with other people
 - visit new places
 - seek employment.
75. "Salvation has come to this house today." (Luke 19:9). Jesus said these words when He visited the house of
- Mary and Martha
 - Simon Peter's mother-in-law
 - Jairus
 - Zaccheaus.
76. Which one of the following is the **main** reason why Judas Iscariot betrayed Jesus? He
- was influenced by satan
 - wanted to please the Pharisees
 - wanted to get some money
 - hoped to become popular.
77. Which one of the following is a command Jesus gave to Peter after His resurrection?
- "Take care of my lambs."
 - "Peace be with you."
 - "Do this in memory of me."
 - "You must strengthen your brothers."

78. The believers in the early church demonstrated their unity **mainly** by
- A. visiting one another
 - B. sharing possessions
 - C. greeting one another
 - D. praying for the sick.
79. Who among the following people baptised the Ethiopian Eunuch?
- A. Philip
 - B. Andrew
 - C. Paul
 - D. Peter
80. Which one of the following fruit of the Holy Spirit was demonstrated by Tabitha when she made garments for widows?
- A. Kindness
 - B. Humility
 - C. Respect
 - D. Tolerance
81. People in the traditional African communities pray to God while facing the mountains because the mountains are
- A. closer to God
 - B. beautiful
 - C. believed to be clean
 - D. believed to be God's dwelling place.
82. Which one of the following is the **main** reason a new born baby is given a name in both Christianity and traditional African communities? To
- A. remember grandparents.
 - B. give identity to the baby.
 - C. reveal the gender of the baby.
 - D. remember important events.
83. Which one of the following is the **best** way of restoring broken relationship in traditional African communities?
- A. Paying fine.
 - B. Sharing a meal.
 - C. Exchanging gifts.
 - D. Shaking hands.
84. Who among the following religious specialists is found in both Christianity and traditional African communities?
- A. Priest.
 - B. Diviner.
 - C. Rainmaker.
 - D. Medium.
85. Which one of the following is the **correct** way of taking care of our environment?
- A. Burning charcoal to get money.
 - B. Harvesting sand to build houses.
 - C. Collecting rubbish from the surroundings.
 - D. Washing clothes in the river.
86. Your desk-mate Damaris borrows your textbook and returns it to you when it is torn. As a Christian, what is the **best** action for you to take?
- A. Refuse to take the book.
 - B. Take it and give it to another pupil.
 - C. Report the matter to your teacher.
 - D. Take it back and repair it.
87. Your classmate Rebecca, tells you she does not like doing household duties because she says such work makes her hands rough. As a Christian, what is the **correct** advice to give her? Tell her
- A. to request her parents to employ a worker
 - B. the importance of helping in house work
 - C. to instruct her younger brother to do the work
 - D. to ask her friends to help do the work.

88. Sharon was involved in the activities listed below during school holidays. As a Christian which one of the activities is the best use of leisure time?
- Celebrating her birthday with friends
 - Attending her cousin's wedding
 - Visiting her aunt
 - Participating in a charity walk.
89. Calvin, a Standard Eight pupil, discovers that three of his classmates steal mobile phones from people and sell them to get money. They ask him to join them in the habit. As a Christian, what is the best action for Calvin to take?
- Refuse and tell them the dangers of stealing.
 - Avoid interacting with them.
 - Ignore them and keep quiet about it.
 - Report the matter to the class teacher.
90. Linda, your classmate, tells you that she is pregnant and the person responsible wants her to carry out an abortion. As a Christian, what should she do? She should
- run away from home
 - keep the baby
 - stop attending school
 - carry out the abortion.

SECTION B
ISLAMIC RELIGIOUS EDUCATION

61. In *Surah Al-Falaq*, a Muslim seeks refuge in Allah from the evil of
- anger
 - greed
 - darkness
 - dawn.
62. According to *Surah An-Nasr*, Muslims should praise Allah and seek for His forgiveness because
- they will be rewarded for good deeds
 - they will have a good relationship with Him
 - He has protected them from danger
 - He is the one who accepts repentance.
63. In which one of the following *Surahs* is man considered to be at a loss?
- Al-Alaq*.
 - Al-Asr*.
 - An-Nas*.
 - An-Nasr*.
64. According to *Surah Al-Quariah*, a Muslim will live a pleasant life in paradise if
- his balance of good deeds is heavy
 - he seeks forgiveness from Allah
 - his balance of good deeds is light
 - he seeks forgiveness from his parents.
65. Below are verses from *Surah Al-Alaq*
- Iqra warabbukal akram*
 - khalaaqal insaana min 'alaq*
 - alladhi 'allama bilqalam*
 - allamal insaana maalam ya'alam*

The correct order of the above verses is

- (ii), (i), (iv), (iii)
- (ii), (i), (iii), (iv)
- (ii), (iv), (iii), (i)
- (ii), (iii), (i), (iv).

66. Which among the following acts makes one to be loved by Allah according to the *Hadith* of the Prophet (P.b.u.h)?
- Keeping off bad behaviour.
 - Keeping off bad friends.
 - Keeping off people's affairs.
 - Keeping off worldly affairs.
67. The right manner of drinking according to the *Hadith* of the Prophet (P.b.u.h) is
- stopping three times to take a breath while drinking
 - starting with *audhubillah* before drinking
 - sitting down while drinking
 - facing Qibla while drinking.
68. A Muslim can know the direction of the Qibla by
- looking at the time by his watch
 - looking at the direction of the wind
 - looking at the movement of the sun
 - looking at the length of his shadow.
69. Which among the following comprises of only *sunnah* acts of *wudhu*?
- Washing the palms, washing the face, wiping the head.
 - Washing the palms, rinsing the mouth, wiping the ears.
 - Washing the palms, rinsing the mouth, washing the face.
 - Washing the palms washing the face, washing the legs.
70. Which among the following items is liable for *Zakat*?
- Farm produce.
 - Household furniture.
 - Personal jewellery.
 - Home utensils.
71. Said, a Standard Seven pupil, wants to observe two days of *sunnah* fast every week. Which of the following days would you recommend to him?
- Tuesday and Thursday.
 - Tuesday and Monday.
 - Monday and Thursday.
 - Monday and Friday.
72. The **main** virtue demonstrated by Muslims when they observe Hajj is
- generosity
 - patience
 - tolerance
 - obedience.
73. A Muslim says '*jazakallah*' when offered a present by a friend because it is a way of
- maintaining friendship
 - thanking the giver
 - encouraging generosity
 - increasing *taqwa*.
74. Muslims can demonstrate the virtue of tolerance by
- allowing non-muslims to practice their religion
 - sharing meals with neighbours
 - assisting those who are in need
 - correcting those who are in the wrong.
75. According to the *Hadith* on generosity. Muslims are encouraged to spend generously because Allah will
- love them
 - enrich them
 - spend on them
 - reward them.
76. Which among the following categories contain the names of prophets only?
- Qabil, Nuh, Yahya Yusuf.
 - Habil, Harun, Musa, Ibrahim.
 - Yusuf, Suleiman, Zubair, Daud.
 - Yusuf, Ayub, Harun, Ilyas.
77. The Zabur was revealed to Nabi
- Issa (A.S)
 - Dawud (A.S)
 - Musa (A.S)
 - Ibrahim (A.S)
78. An attribute of Allah that describes him as the opener is
- Al-Baari
 - Al-Khaaliq
 - Al-Fattah
 - Al-Razzaq.

79. Which among the following statements is **true** about the Day of Judgement? It is the day when
- Nabi Issa will come back
 - angels will come to earth
 - human beings will enter paradise
 - people will account for their deeds.
80. A Standard Six teacher was distributing sweets in class and one of the pupils missed. Ali decided to give his sweet to the pupil who missed. This act by Ali demonstrated
- sacrifice
 - hospitality
 - Ihsan
 - Shukur.
81. Fatma, a Standard Four pupil, complains to you that her father does not allow her to get out of the house or play with friends. The **right** advice to give Fatma is to tell her to
- complain to her mother
 - obey her father's rules
 - go out and play with friends
 - do her homework.
82. In which one of the following ways do Muslims demonstrate co-operation?
- Performing *swalat* in congregation.
 - Assisting the poor in the society.
 - Working together to clean the environment.
 - Selling *halal* goods.
83. Below are events that took place during the early life of the Prophet (P.b.u.h)
- death of his mother Amina
 - taken by Halima saadiya
 - marriage to Bibi Khadija
 - journey to Sham with AbuTalib
- Arrange the above events in the **correct** order in which they occurred
- (i), (iv), (ii), (iii)
 - (i), (ii), (iv), (iii)
 - (ii), (iv), (i), (iii)
 - (ii), (i), (iv), (iii).
84. Which among the following was the first battle to be fought in Islam?
- Badr.
 - Uhud.
 - Khandaq.
 - Hunain.
85. The reason why Muslims conquered Makka was because
- the Qureish persecuted the Muslims who remained in Makka
 - the Quraish broke the terms of the Treaty of Hudaibiya
 - they wanted to have control of the Holy city
 - they wanted to reunite with their relatives.
86. During Hijatul Wida, the Prophet (P.b.u.h) gave his sermon at mount
- swafaa
 - Hira
 - Arafaat
 - Thaur.
87. Muslims celebrate *Idd-ul-Adha* to commemorate
- the prophet's Hijra to Madina
 - the bravery of Nabi Yusuf (A.S)
 - the struggle of Nabi Musa (A.S)
 - the sacrifice of Nabi Ibrahim (A.S).
88. Which one of the following events took place during the month of Muharram?
- Nabi Ibrahim (A.S) was saved from the fire
 - Nabi Musa (A.S) was saved from Firaun
 - The prophet (P.b.u.h) migrated to Madina
 - The prophet (P.b.u.h) was taken for *Isra wal Miiraj*
89. Who among the following prophets was ordered to construct the ark by Allah?
- Nuh (A.S).
 - Adam (A.S).
 - Musa (A.S).
 - Ibrahim (A.S).

90. Qabeel the son of Nabi Adam killed his brother Habil because
- Adam appointed Habil to inherit him
 - he felt that Habil was richer than him
 - Habil's sacrifice was accepted and his was rejected
 - Habil was loved more by his parents.

SECTION C
HINDU RELIGIOUS EDUCATION

61. Paramatma created the universe because he is
- omnipotent
 - omnipresent
 - invisible
 - invincible.
62. Which one of the following groups of words describe *sat – chit – Anand*?
- Divinity, eternity, knowledge.
 - Divine, accessible, knowledge.
 - Eternal, knowledge, bliss.
 - Eternal, divine, knowledge.
63. Which one of the following institutions was established by Swami Dayanand and Saraswati?
- Arya Samaj.
 - Brahm Samaj.
 - RamKrishna Mission.
 - Hare Krishna Mission.
64. During which *avatar* of Lord Vishnu did Lord Shiva drink the poison?
- Matsya*.
 - Kalki*.
 - Kurma*.
 - Varaha*.
65. Who among the following Gurus declared the Granth Sahib as a living Guru?
- Gobind Singh.
 - Nanakdev.
 - Arjan dev.
 - Tegh bahadur.

66. A Buddhist devotee gets *Nirvan* by
- doing *puja* in a *stupa*
 - meditating regularly
 - fasting always
 - getting rid of desires.

67. Which one of the following scriptures is correctly matched with its author?

Author	Scripture
A. Swami Bhadrabahu	Kalpasutra.
B. Swami Dayanand	Tirukural.
C. Sage Valmiki	Satyarth Prakash.
D. Saint Thiruvalluvar	Ramayan.

68. A similarity between Dhammpada and Mahabharat is that they both

- contain the theory of law of Karma
- lead to the practice of Ahimsa
- are written in Sanskrit language
- give their teachings in Katha form.

69. Which one of the following principle of Dharma should a student follow during examination?

- Kshma*.
- Ahimsa*.
- Aparigraha*.
- Dhruiti*.

70. Which one of the following statements about *Atma* is correct? It

- activates the body
- enjoys Karmas
- experiences suffering
- fulfils its desires.

71. Standard Seven students were given one loaf of bread each as they visited a bakery. *Gita* shared her loaf of bread with a beggar. The principle practised by *Gita* is

- Dharama ki kirat*
- Wand ke shakna*
- Rahit daan*
- Bharosa daan*.

72. Rohit took part in the following activities during his free time. Which one of the activities did he do without attachment?

- A. He sat for the exams.
- B. He represented his school in a junior competition.
- C. He took part in a swimming gala.
- D. He gave water to a stray dog.

73. Jains have their meals before sunset to

- A. prevent the insects from being killed
- B. help their digestion
- C. give them more leisure time
- D. enable them to have more time to pray.

74. The following are the beliefs of a Hindu

- (i) *Atma* is immortal
- (ii) life does not end with death
- (iii) a person's birth is according to his *Karma*

Which one of the following principles of Hindu is expressed by the above statements?

- A. *Prarthana*
- B. *Pranidaya*
- C. *Punarjanam*
- D. *Purushastha*

75. Which one of the following Sanskars according to Hindu Dharma is performed at the age of six years.

- A. *Naam Karan*
- B. *Upnayan*
- C. *Nishkraman*
- D. *Jatkarma*

76. Hindu festivals are celebrated with light because it is a symbol of

- A. love
- B. wisdom
- C. peace
- D. unity.

77. The reason why Sikhs visit Akal Takhat Sahib in Amritsar is

- A. Because the dome of the temple is covered with Gold
- B. Sri Guru Gobind Singhji was initiated into Khalsa
- C. Sri Guru Nanak Devji was enlightened here
- D. It is the supreme seat of Sri Guru Granth Sahib ji

78. Which one of the following elements is **mainly** required to be present during the performance of *Vivah Sanskar*?

- A. Jal.
- B. Vaya.
- C. Prithvi.
- D. Agni.

79. Which one of the following is a ritual that is performed by a devotee during *Amarnath Yatra*?

- A. Chanting continuously
- B. Donating food
- C. Fasting throughout
- D. Climbing mountains.

80. Hindus make Rangoli designs on their door steps during Diwali **mainly** to

- A. Get blessings from Lord Ram
- B. Welcome Laxmi Devi
- C. Beautify their homes
- D. Welcome visitors.

81. Before entering a *Derasar* Jains touch the threshold to show respect to

- A. all visitors
- B. enlightened beings
- C. devotees
- D. Mijaris.

82. A teacher of Yoga gave the following instructions to her pupils for an Asana
- stand upright
 - feet together
 - slowly lift your arms
 - inhale – stand on toes
 - stretch yourself and feel the pull
- The above statements describes the
- Ardhakti chakra*
 - pad hastasan*
 - Tadasam*
 - Vajrasana*.
83. The **main** reason why meditation is important to a yoga practitioner is because it
- improves health
 - gives peace
 - increases concentration
 - helps self examination.
84. “You have to sacrifice your personal comfort for saving Sanatan Dharma” These words were said to Samarth Ramdas in a vision by
- Lord Shiva
 - Lord Vishnu
 - Lord Krishna
 - Lord Ram.
85. The **best** way for a Hindu to observe his Dharma is by
- doing his duty
 - having good thoughts
 - assisting in charitable causes
 - helping his community.
86. Children show their gratitude to both parents and teachers by
- studying hard for good grades
 - running errands willingly
 - obeying and respecting them
 - assisting in educational projects.
87. Which one of the following is the **wrong** way of caring for trees?
- Watering them regularly.
 - Cutting them indiscriminately.
 - Pruning the branches.
 - Giving compost to help the trees grow.
88. The Kenyan Government has banned the use of plastic bags to
- control climate change
 - protect the animals
 - conserve the environment
 - improve the economy.
89. ‘*Namaste*’. the Hindu greeting is done with folded hands and a bowed head aimed at the person’s
- head
 - hands
 - eyes
 - heart.
90. According to the Hindu calender *Adhik maas* occurs
- after two and a half years
 - in alternate years
 - after three and a half years
 - after three years.